

# AP-750

Proyector acústico / Sound projector

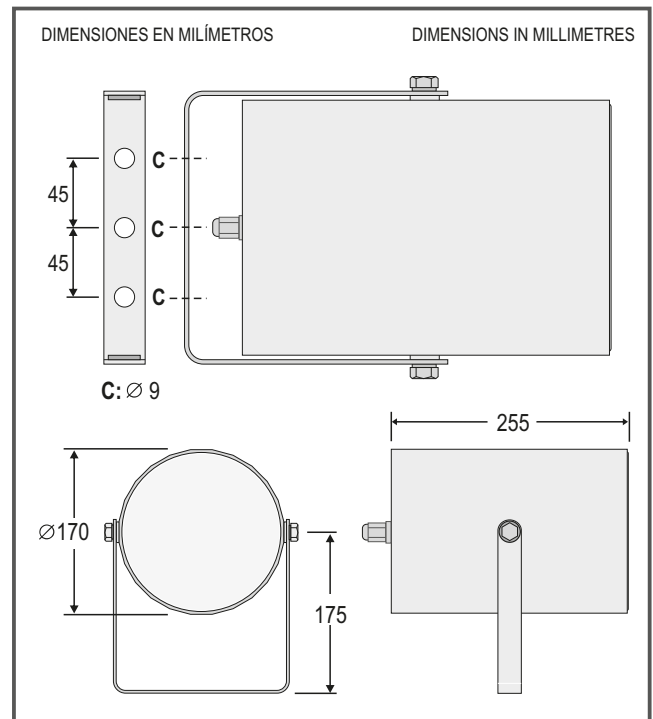
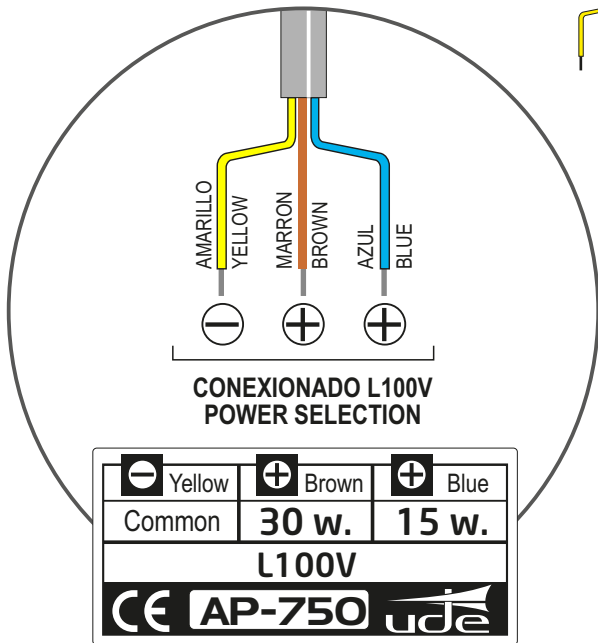
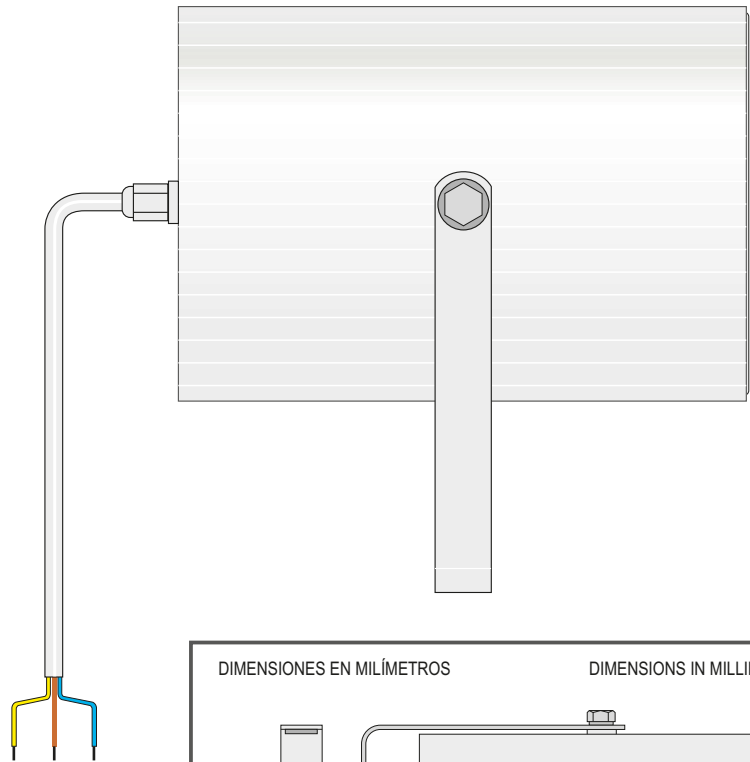
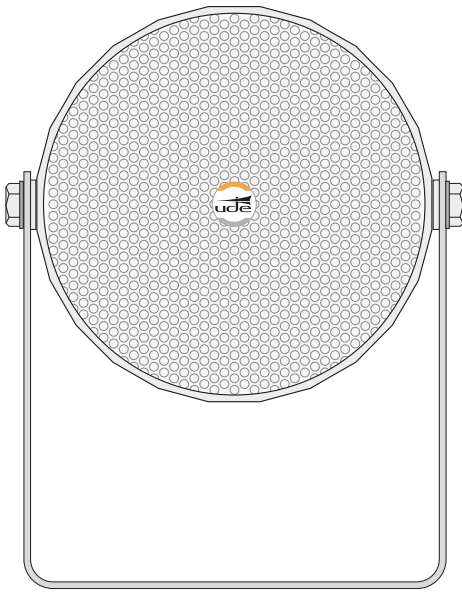

Altavoz para palabra y música, de uso en interior y exterior, con transformador de línea incorporado. Resistente a la intemperie (IP-66).

Speaker for voice and music purpose, for indoor and outdoor use, with line transformer built-in. Weather-resistant (IP-66).

## CARACTERÍSTICAS TÉCNICAS

- <b>Altavoz:</b>	6,5".	- <b>Material:</b>	Aluminio.
- <b>Potencia nominal (RMS):</b>	30 W.	- <b>Color:</b>	Blanco.
- <b>Potencia L 100 V.:</b>	30 - 15 W.	- <b>Peso:</b>	2,9 Kg.
- <b>Banda pasante:</b>	100 -17.000 Hz.	- <b>Escuadra fijación:</b>	Inox.
- <b>SPL (1 W/1 KHz/1 m):</b>	93 dB.	- <b>Tornillería:</b>	Inox.
- <b>Angulo de dispersión:</b>	90°	- <b>Entrada cable:</b>	Prensaestopas PG7.

## TECHNICAL CHARACTERISTICS

- <b>Speaker:</b>	6,5".	- <b>Material:</b>	Aluminium.
- <b>RMS Power:</b>	30 W.	- <b>Colour:</b>	White.
- <b>100 V. Line power range:</b>	30 - 15 W.	- <b>Weight:</b>	2,9 Kg.
- <b>Bandwidth:</b>	100 -17.000 Hz.	- <b>Support bracket:</b>	Stainless steel.
- <b>SPL (1 W/1 KHz/1 m):</b>	93 dB.	- <b>Screws:</b>	Stainless steel.
- <b>Dispersion angle:</b>	90°.	- <b>Lead input:</b>	Cable gland PG7.

Preparado para adaptarse a la norma EN-54

Comply with EN-54 standard



EQUIPOS Y SISTEMAS MEGAFONÍA / INTERCOM • PUBLIC ADDRESS SYSTEMS

UNIÓN DESARROLLOS ELECTRÓNICOS

Tel.: +34 934 772 854 / +34 609 914 787 • ude@udeaudio.com • BARCELONA - SPAIN

www.udeaudio.com

rev.0 | 610.532c | 1 / 9