



## Main characteristics

- ✓ Built-in D-Class amplifier (stereo) 2x10W RMS.
- ✓ Functional design that harmonizes with the majority of elements used in decoration.
- ✓ Multiple music source options: FM Tuner, SD, USB, Bluetooth, AUX1, AUX2.
- ✓ Adjustable sensibility for AUX inputs.
- ✓ Digital FM tuner. Up to 30 saved presets.
- ✓ IR Remote controller included.
- ✓ Assembly options: Surface mount (surface box included) and flush mount.
- ✓ Password protected bluetooth connection

<b>Power:</b>	2x10W.
<b>Impedance:</b>	8Ω.
<b>Distortion:</b>	<=0.03%.
<b>Signal-Noise Ratio:</b>	>81 dB.
<b>Frequency response:</b>	20Hz to 20KHz.
<b>FM Range:</b>	87 Hz - 108 MHz.
<b>Audio formats:</b>	MP3 - WMA - WAV - FLAC
<b>Mini SD Card:</b>	32GB max.
<b>USB:</b>	32GB max.
<b>Bluetooth:</b>	BT2.1 +EDR
<b>Input sensibility AUX1/AUX2:</b>	S1: 500mV / 1 kΩ.
<b>-Adjustable with frontal controls:</b>	S2: 1000mV / 1 kΩ.
<b>Power supply:</b>	100-240 VAC (50/60 Hz).
<b>AV-220 Composition:</b>	1 AV-220 station. 1 Remote controller. 2 Fixing screws for cover. 1 Box for surface mount assembly.

### ACCESSORIES (optional)

- Flush mount box  
Ref. UDE 305.332
- Embedded mount box  
Ref. UDE 305.306

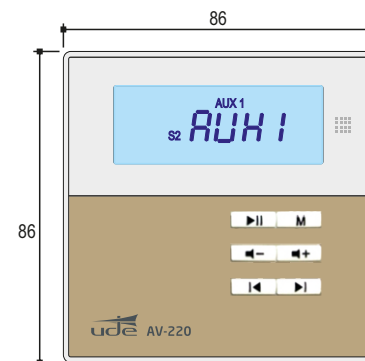
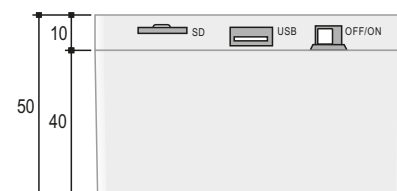

DIMENSIONS IN MILLIMETERS

## Front panel

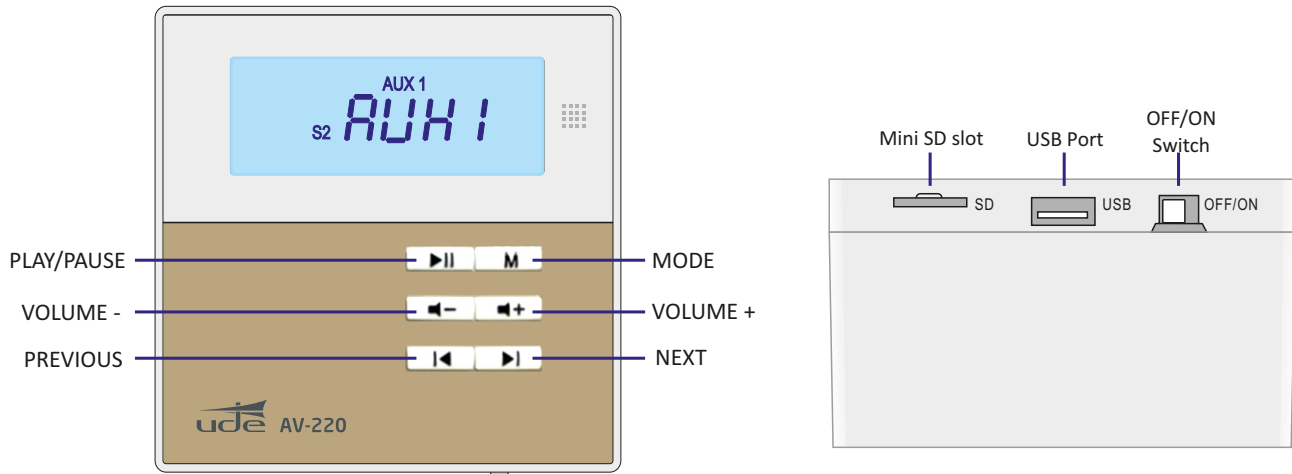



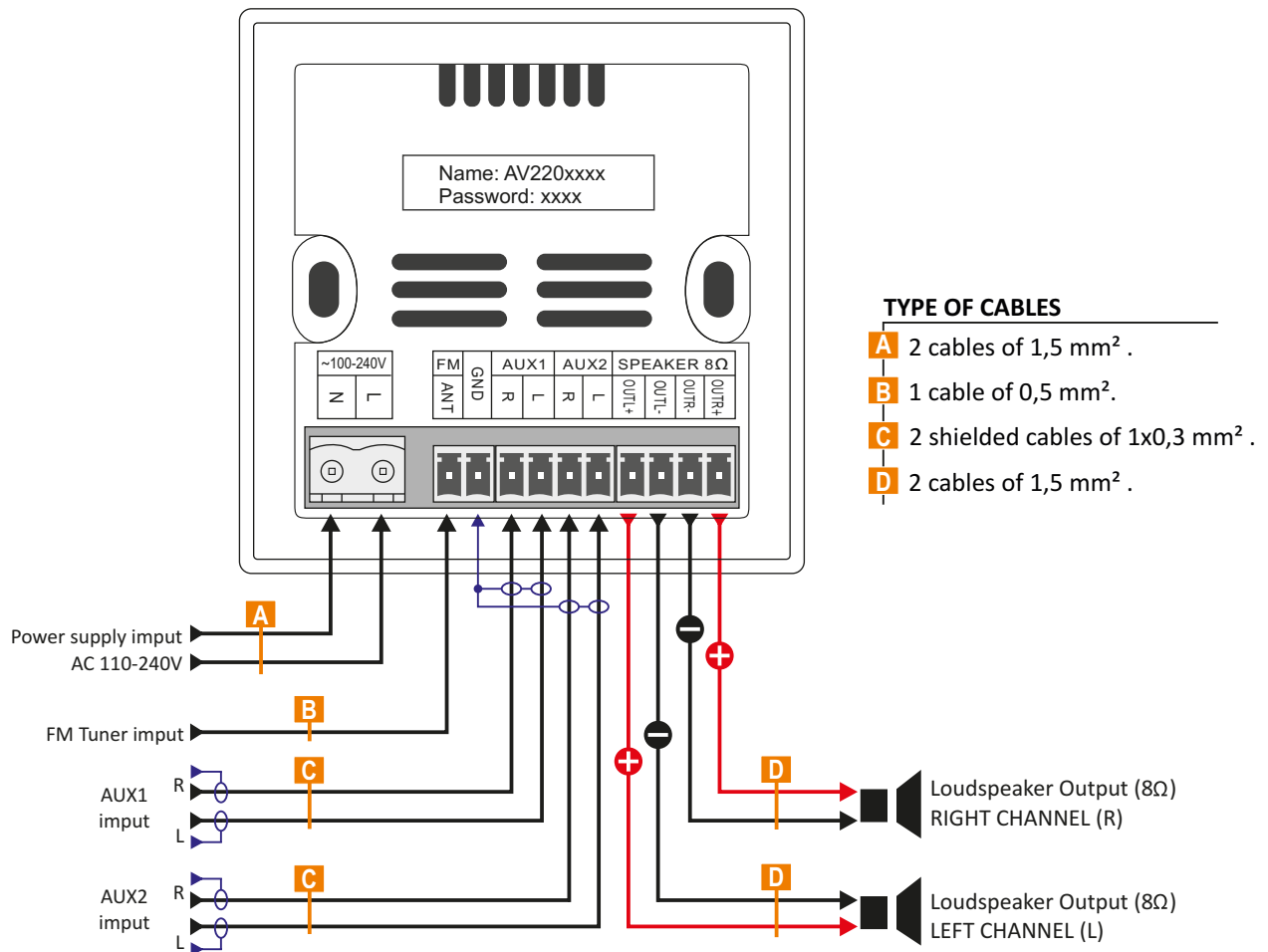









## Connection diagram



## Remote control

---



-  **STANDBY / ON.** Turn on the equipment
-  **PROGRAM SELECTION MODE (Mode).**  
 Press to change, following this order: (FM>SD>USB>BT>AUX1>AUX2).  
 Select the desired mode.
-  **MUTE.**  
 Press to silence, in the display the file number blinks. Press again to activate the sound.
-  **EQUALIZATION.** Select the type of equalization  
 NORMAL >JAZZ>ROCK>POP
-  **PLAY / PAUSE.** Pressing the button will start playing the file with the number showing on the display. Press the button again to pause it.
-  **NEXT.** Selects next file to play.
-  **PREVIOUS.** Jumps back to the previous file to play.
-  **VOLUME (+).**  
 The digital volume can be adjusted from U00 to U32. +2 intervals.
-  **VOLUME (-)**  
 The digital volume can be adjusted from U00 to U32. -2 intervals.
-  **PLAYING MODES SELECTION.**  
 Press the key to play successively one song (ONE) or the entire list (ALL).
-  **NUMERIC KEYS.**  
 When you are in the SD card mode: choose directly the file to play by pressing the corresponding numeric key.
-  **9**  
 When you are in FM Tuner mode: enter a FM frequency value (\*) directly by pressing the numeric keys.  
 (\*) The range of frequencies are 0870-1080.  
 Example: press 0920 to select the 92,0 MHz frequency.





## Operating modes

---



### 1.FM

Press the “**M**” button to select the **FM** Tuner mode.

**Automatic search:** hold down “” to start seeking the available stations, the system will save automatically the effective radio stations. The first time, do this with the antenna connected.

**Manual fine tuning mode:** hold down “” or “” to enter to the fine tuning mode, then hold down “” or “” to manually adjust the current channel. If we stop pressing any button during 5 seconds, it will save the current channel and exit the fine tuning mode.

**Mute:** short press “” to mute the FM Tuner.

**Change station:** short press “” or “” to change the saved station.

**Volume control:** short press “” or “” to increase or reduce the current volume.



### 2.SD

Press the “**M**” button to select the **CD** mode.

When there is no **SD** card, the display will show “**NO**” blinking.

When there is a **SD** card, it will read it and the display will show “---” when there is no music or unable to decode.

If the music is compatible then it will play it automatically and show the time progress.

**Play control:** short press “” or “” to change to the previous or next song, hold down to fast forward or fast reverse.

Press “” to play or pause.

**Volume control:** short press “” or “” to increase or reduce the current volume.

### 3. USB Device

Press the “**M**” button to select the **USB** mode.

When there is no **USB**, the monitor will show “**NO**” blinking.

When there is a **USB**, it will read it and the monitor will show “---” when there is no music or unable to decode.

If the music is compatible then it will play it automatically.

**Play control:** short press “” or “” to change to the previous or next song, hold down to fast forward or fast reverse.

Press “” to play or pause.

**Volume control:** short press “” or “” to increase or reduce the current volume.

### 4. Bluetooth Connection

Press the “**M**” button to select the **BT** mode.

When there is connection, the monitor will show “**BT**” blinking.

The AV-220 will be displayed on other devices as “**AV220XXXX**” where the X's correspond to a numeric code. These last 4 digits refer to the password that allows the device to be paired. You can also find the device reference and password on the packaging box, as well as on the back of the AV-220.

When connected, the display will show “BT” permanently.

**Volume control:** short press “” or “” to increase or reduce the current volume.

### 5. AUX

Press the “**M**” button to select the **AUX1** (or **AUX2**) mode.

**Play control:** short press “” to play or pause. When it is muted, the monitor LCD will blink.

**Volume control:** short press “” or “” to increase or reduce the current volume.

**Sensitivity adjustment:** long press “” or “” to adjust the sensitivity, it can be switched between S1 and S2

- 1** Extract the interior chassis from the cover.  
Pressure shall be performed to the 4 lateral tabs and extract it.

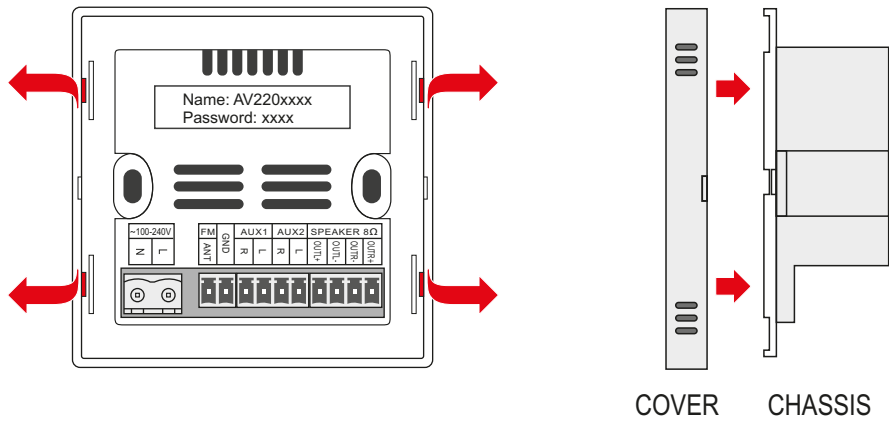

- 2** Connect and introduce the chassis in the surface mount box.  
Fix it with the two screws supplied.

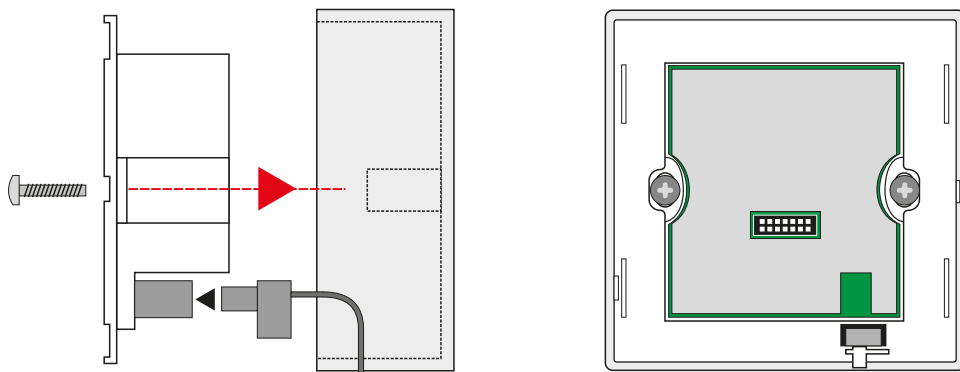

- 3** Attach again both covers  
Pressure the covers until they fit.

- 4** Once the AV-220 is installed on the surface,  
to extract the cover make pressure in the lateral slot on the right side.

