

## Installation - Configuration - Use

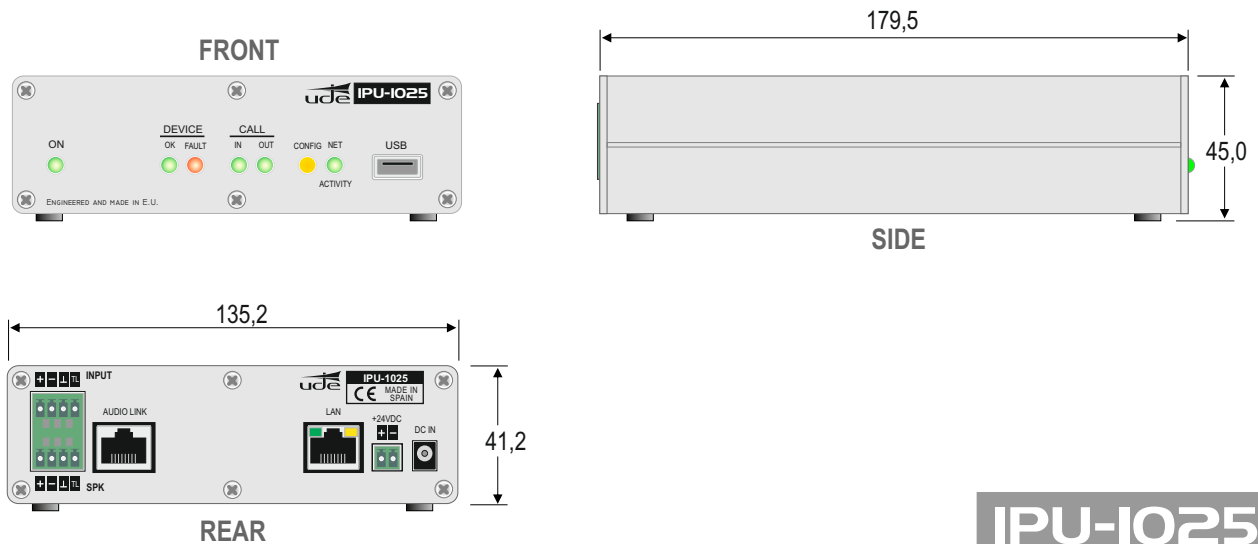

## INDEX

	PAGE
1.- DESCRIPTION	2
2.- TECHNICAL DATA	3
3.- TYPICAL APPLICATION OF IPU-100	4
4.- DESCRIPTION OF CONNECTIONS.	5
4.1.- Front view.	5
4.2.- Rear view.	7
5.- DEVICE CONFIGURATION (WEBSERVER).	8
5.1.- Home page (HOME)	8
5.2.- SIP Configuration (SIP)	10
5.3.- Extension SIP Configuration (EXTENSIONS)	13
5.3.1.- Erasing & editing	15
5.3.2.- P.A. zones edit page	16
5.4.- Device configuration (DEVICE)	22
5.5.- Network configuration LAN. (NETWORK)	25
5.6.- Time configuration (TIME).	27
5.7.- Date configuration (DATE).	27
5.8.- Password configuration device (PASSWORD).	28
5.9.- Reset to factory default (RESET TO FACTORY)	29
5.10.- Remote Reboot (REBOOT)	29

## 1.- DESCRIPTION

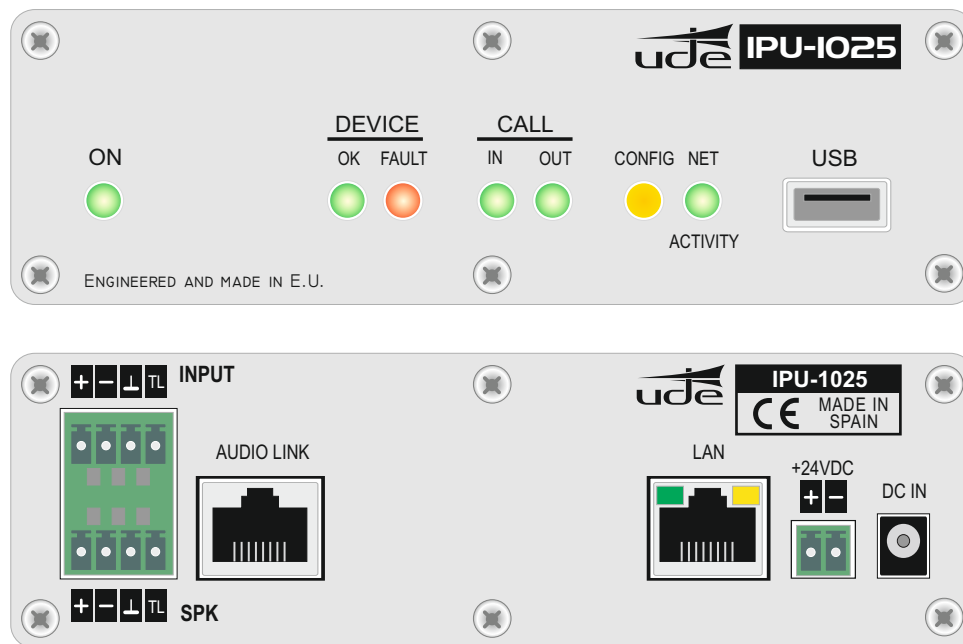

The public address system for IP networks of UNION DESARROLLOS ELECTRONICOS allows the creation of conventional PA and security systems, allowing us to interconnect with IP devices following SIP standard. Unión Desarrollos Electrónicos Audio offers the **IPU-360 SIP** server that will centralize and coordinate all communication of IP paging elements ensuring maximum functionality of all of them, with minimal risk.

The **IPU-1025** has included many functions within the same device: decoder and audio manager. With these functions allow the user to:

- Connect to loudspeakers, horns or trumpets directly through the integration of a class D amplifier with a maximum power of 25W.
- This amplifier has a low impedance output allows direct connection to PA speakers.
- Connect the decoder within an IP network.
- Connect an audio source.
- Connect a microphone with or without phantom power for simple messaging to the IP network.

The **IPU-1025** decoder becomes the key element to ensure compatibility with all loudspeakers and horns/trumpets on the PA portfolio of UNION DESARROLLOS ELECTRONICOS, so that you can use to adapt older installations today. Besides concentrating on just one set of IP decoder with built-in amplifier allows savings in space, power and price of the final device.

The IP system is suitable for any type of installation: schools, sports centers, industrial areas, department stores, airports, etc ...

It is recommended for remote management applications such as: Remote management of parking, remote management facilities on installation that require sound systems.

The **IPU-1025** allows encoding and decoding multiple audio formats, such as G-711 and G-722 suitable for Voice and PCM suitable for Background Music environment applications.

The **IPU-1025** may be operated in two different ways, making it very versatile in any installation:

- 24V AC Adaptor (18..30V).
- 24V backup battery (18..30V).

The **IPU-1025** configuration by the technician is done by accessing to the integrated Webserver using a password, but if the user or operator needs to monitor the status of it, then also can be done remotely, just knowing the IP address of the device.

2.- TECHNICAL DATA

TECHNICAL FEATURES	VALUES												
<b>CPU Principal</b>	PIC32 CPU (Microchip™ powered).												
<b>LAN port (Ethernet)</b>	<ul style="list-style-type: none"> <li>- 10/100Mbit, Full/Half duplex, Autonegociación, AutoMDI/MDI-X, Compatible con PoE (IEE802.3af).</li> <li>- LINK and ACTIVITY leds included.</li> <li>- RJ-45 socket type (8 pins).</li> <li>- IP protocols supported:                             <ul style="list-style-type: none"> <li>IPV4 (IPV6 not supported).</li> <li>DHCP (Auto/Manual).</li> <li>TCP/IP.</li> <li>UDP.</li> <li>RTP.</li> <li>SIP.</li> <li>HTTP, AnnouncelP.</li> </ul> </li> </ul> The IPU-100 can only process non-fragmented packets.												
<b>AUDIO LINK port</b>	Dedicated port to the connection with the IP Paging Desk (IPU-100P), that includes: <ul style="list-style-type: none"> <li>- Digital Control Bus: RS485 (115200bps, 8bits, No Parity, 1 stop bit, No flow Control).</li> <li>- Balanced Audio Output (0dB, 0.775mVrms/600Ω).</li> <li>- Balanced Audio Input (0dB, 0.775mVrms/10KΩ).</li> </ul>												
<b>INPUT port</b>	Dedicated port to connect to analog input audio devices: <ul style="list-style-type: none"> <li>- Differential Microphone (2mVrms/600Ω, Phantom 12V).</li> <li>- LINE IN (300mVrms/10KΩ, connection to auxiliary Background Music devices).</li> <li>- Activation through REMOTE IN (Close Contact) or VOX function.</li> </ul>												
<b>SPK port</b>	Dedicated port to the connection of loudspeakers, horns or trumpets at low impedance: <ul style="list-style-type: none"> <li>- Audio Output (25W/8Ω, THD &lt;10%).</li> <li>- Activation of REMOTE OUT.                             <ul style="list-style-type: none"> <li>- Close Contact (INCOMING call on-live). Maximum Load capability: 0.5A at 24Vdc.</li> <li>- Open Contact (no INCOMING call received).</li> </ul> </li> </ul>												
<b>USB port</b>	USB 2.0 Type A.												
<b>LEDs (only informative)</b>	Power <b>ON</b> , LAN Activity ( <b>NET ACTIVITY</b> ), <b>CONFIG</b> mode, OUTCOMING call ( <b>CALL OUT</b> ), INCOMING call ( <b>CALL IN</b> ), Device properly register on SIP server ( <b>DEVICE OK</b> ), Failure on Device ( <b>DEVICE FAULT</b> ).												
<b>System Clock Backup Supply</b>	3V Lithium Battery, CR2025 type (Not rechargeable)												
<b>Audio Format (Encoder / Bandwidth)</b>	<table border="1"> <thead> <tr> <th>Included Codec:</th> <th>Bandwidth</th> </tr> </thead> <tbody> <tr> <td>G.711 (u-Law). 8 bits logarithmic compression and 8KHz sampling frequency.</td> <td>64 Kbps</td> </tr> <tr> <td>G.711 (a-Law). 8 bits logarithmic compression and 8KHz sampling frequency.</td> <td>64 Kbps</td> </tr> <tr> <td>G.722(ADPCM).8 bits Adaptive Linear Compression and 16KHz sampling frequency.</td> <td>128 Kbps</td> </tr> <tr> <td>PCM. 16 bits without compression and 8KHz sampling frequency.</td> <td>128 Kbps</td> </tr> <tr> <td>PCM. 16 bits without compression and 16KHz sampling frequency.</td> <td>256 Kbps</td> </tr> </tbody> </table>	Included Codec:	Bandwidth	G.711 (u-Law). 8 bits logarithmic compression and 8KHz sampling frequency.	64 Kbps	G.711 (a-Law). 8 bits logarithmic compression and 8KHz sampling frequency.	64 Kbps	G.722(ADPCM).8 bits Adaptive Linear Compression and 16KHz sampling frequency.	128 Kbps	PCM. 16 bits without compression and 8KHz sampling frequency.	128 Kbps	PCM. 16 bits without compression and 16KHz sampling frequency.	256 Kbps
Included Codec:	Bandwidth												
G.711 (u-Law). 8 bits logarithmic compression and 8KHz sampling frequency.	64 Kbps												
G.711 (a-Law). 8 bits logarithmic compression and 8KHz sampling frequency.	64 Kbps												
G.722(ADPCM).8 bits Adaptive Linear Compression and 16KHz sampling frequency.	128 Kbps												
PCM. 16 bits without compression and 8KHz sampling frequency.	128 Kbps												
PCM. 16 bits without compression and 16KHz sampling frequency.	256 Kbps												
<b>Outcoming Call to default extension activation</b>	REMOTE IN input (switch type). <ul style="list-style-type: none"> <li>- Close Contact to start and hold the out coming call.</li> <li>- Open Contact to cancel the out coming call.</li> <li>VOX control (Threshold level and Pre/Post activation time settings).</li> </ul>												
<b>Remote Management</b>	Using the Webserver built-in in the device the following remote features are available: <ul style="list-style-type: none"> <li>- Functionality Supervision.</li> <li>- Password Management.</li> <li>- Configuration of : SIP, LAN, Time/Date, Device.</li> </ul>												
<b>Security Level</b>	Password system of 8 alphanumeric characters.												
<b>Power</b>	Main: <ul style="list-style-type: none"> <li>- AC Adaptor (recommended): 24Vdc (IPW-25). 0.9A PPTC internal fuse (resettable).</li> <li>- Backup: Battery (external): 24Vdc (18..30V). 0.9A PPTC internal fuse (resettable).</li> </ul>												
<b>Consumption</b>	32W máx. at 24Vdc. (IPU-100P mode: 38W)												
<b>Operation temperature</b>	-5 a +45°C (0 a +40°C, recommended)												
<b>Storage temperature</b>	-15 a +60°C												
<b>Humidity</b>	5% a 95%, without condensation												
<b>Weight</b>	0.6 Kg												

### 3. TYPICAL APPLICATION OF IPU-100.

Figure 1 provides an example configuration of the PA system for IP networks of UDE.

The audio decoder IPU-1025 model is the element that allows the decoding of audio sent digitally to a conventional audio signal to be amplified conveniently and connected directly to speakers, horns or trumpets.

The IP Paging Desk (IPU-100P) with color touch screen, where the operator can select the zones where the message must be activated once you press and hold the button of "PTT" (Talk).

In addition, the SIP server (IPU-360) which acts as intermediary between all IP devices connected to the LAN working.

As can be seen our IPU-1025 devices can connect to the wide range of speakers, horns and trumpets of UNION DESARROLLOS ELECTRONICOS.

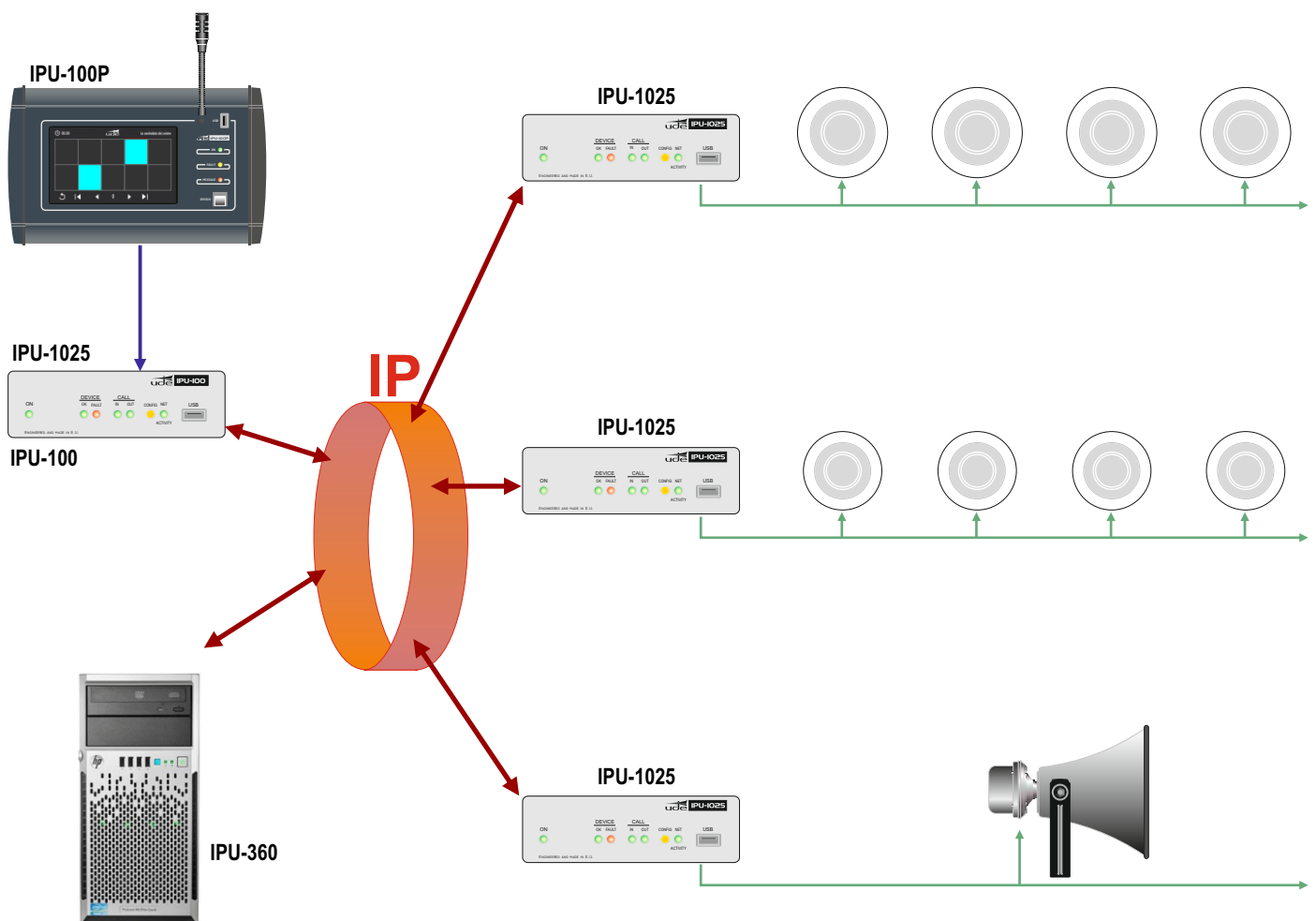

## 4.- DESCRIPTION OF CONNECTIONS

### 4.1. Front view

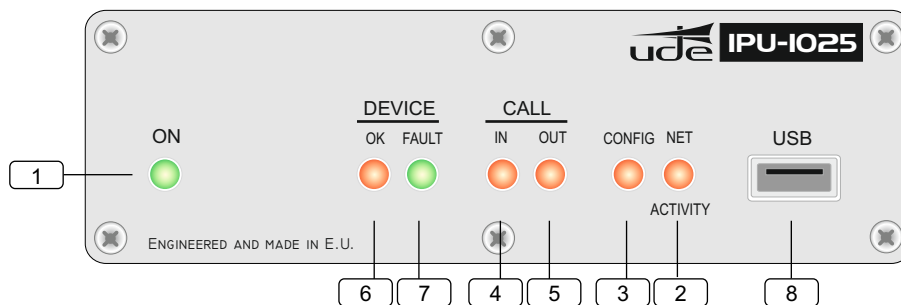

- 1 **LED ON.** This indicator shows that the equipment is properly powered and that the main application is running.
- 2 **LED NET ACTIVITY.** This indicator shows the data activity when is connected to an Ethernet LAN. When you receive IP packets should be the LED blinking.
- 3 **LED CONFIG.** This indicator shows that session of configuration (Setup) by Webserver is open.  
*NOTE: This LED appears blinking (orange) while WEBSERVER session is open, although the operator / administrator has finished with maintenance. It is desirable to close the work session when this is over to indicate properly the status and do not allow confusion with front indicators.*
- 4 **LED CALL IN.** This indicator is set when an incoming call (active decoder mode) is received and accepted, and is active while the call emitter keep the channel open. Once emitter point drop the call, the server of the installation disable the call and the CALL IN indicator will turn off. When the LED remains off indicates that the IPU-1025 is not getting any calls.
- 5 **LED CALL OUT.** This indicator is activated when the IPU-1025 device is the generator of a voice call, there are two types of call:

Using a IP Paging Desk Controller (IPU-100P) connected to the IPU-1025 reports that the user is performing an outgoing call to one or more areas. So that the LED is turned on the following sequence of events must happen.

- 1a. The IPU-100P device makes a request to the IPU-1025, to provide an outgoing call to one or more paging zones selected by touch screen and Pressing the PTT button (talk).
- 2a. The IPU-1025 processes the request and sends the information through the IP network to the server to communicate with selected decoders. The Call Out LED has not yet been activated, communication is not established.
- 3a. The IPU-360 processes and sends packets with information to the IPU-100 that communication begins feasible. At this time the CALL OUT LED turns ON.
- 4a. This indication remains active until the user releases the call button. At which the IPU-1025 reports to the installation server the call cancelling and when the cancellation is accepted, then the CALL OUT indication is turned off, releasing all resources used during communication.

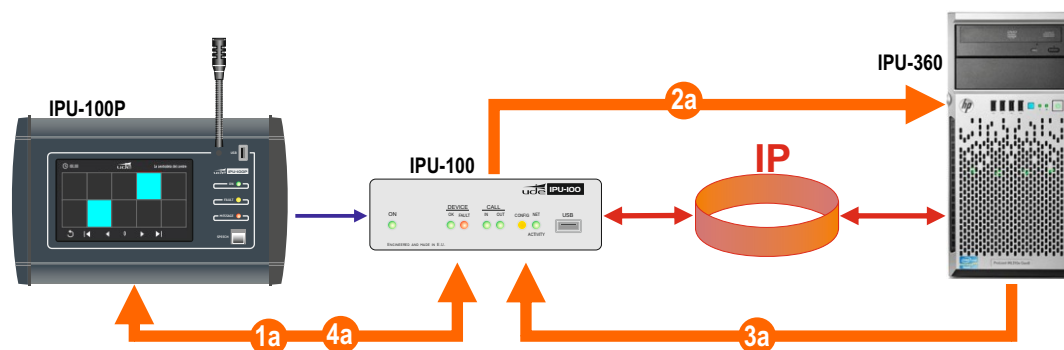

Encoding directly the audio signal connected to INPUT (+/-) of the IPU-1025, the device is able to detect the audio modulation and generate a call to the extension that has been programmed on the Webserver. The IPU-360, Public Address IP manager, will determine the priority and connect the call to the appropriate paging zones. Later will confirm the call to the IPU-1025, audio encoder, which turns on the CALL OUT LED. While audio modulation was present or remote input was active, the IPU-1025 input will be encoded and sent through the IP network showing your work status through the LED CALL OUT.

### 4.1. Front view

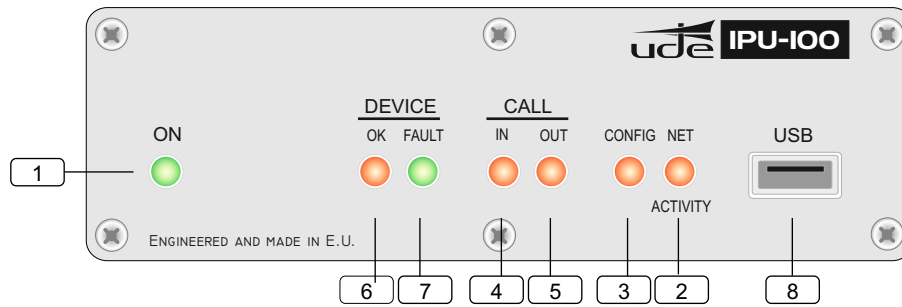

- 6 LED DEVICE OK.** The IPU-1025 device that registers with the IPU-360 server correctly and received the authorization to use the IP installation, will remain with the DEVICE OK indicator on.  
The correct register requires a configuration made on our IPU-100 and another on the IP server. This action must be performed only by authorized service personnel.



#### Remember!

If you experience problems with the DEVICE OK, so if it ever turns off sporadically, then it is recommended to contact with your local network administrator (LAN).

- 7 LED DEVICE FAULT.** The public address system for IP networks according to the SIP standard, requires signaling data in order to establish a secure and reliable communication, executed in the initialization of a device to connect to the LAN (Local Area Network) or periodically to refresh the status of the IPU-360 server.

The IPU-1025 automatically executes a registration attempt to the server configured in its settings and every time you restore the power will also run the connection attempt. During the process, the device remains without registration with the IPU-360 server, the DEVICE FAULT LED is RED, indicating that there is a connection problem with the server so the device is not operating temporarily. Along with the lighting there is a error beep signal that emits periodic tones indicating the inoperability of the encoder / decoder (beep sound can be disabled from the Webserver).

- 8 Connector USB.** The device allows the updating of internal management software from the USB terminal.

## 4.- DESCRIPTION OF CONNECTIONS

### 4.2. Rear view

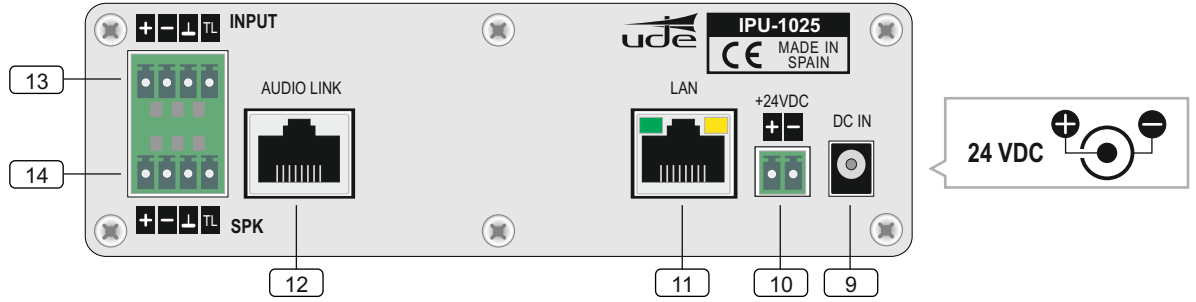

- 9 **DC IN.** This connector allows us to power the device using a 24Vdc external power supply ( model: IPW-25). These include that of the 2 powering methods available on the IPU-1025, the power input with the IPW-25 AC adapter (DC IN), is the highest priority input and disables the battery backup input, which only supply power if the voltage delivered in the DC IN terminal is absent or is lower than 18Vdc.

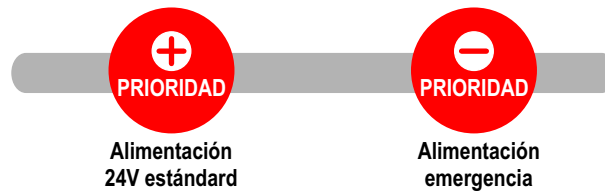

- 10 **+24 VDC.** The terminal allows IPU-1025 connection to a battery backup system to prevent the system fails during a primary power failure (IPW-25).

- 11 **LAN.** The LAN port allows the connection of the IPU-1025 to the IP network. It supports automatically low speed networks 10-BASET (10Mbits) and improved speed networks 100-Base-TX (100Mbits). The left indicator reports data activity on the LAN (ACTIVITY), while on the right it is properly linked to the LAN (LINK).

**Attention!** The IPU-1025 can only process non-fragmented packets.

- 12 **AUDIO LINK.** This connector allows connection of an IPU-100P or allows the expansion and control, of external devices through the digital bus, also has a balanced analog audio input and one output that allow the exchange of audio between the IP Paging Desk Controller and the IPU-1025 (encoder / decoder). We recommend using UTP wiring to connect both devices. The IPU-100P (IP Paging Desk) can be powered via the AUDIO LINK when you are less than 50 meters of the IPU-100.

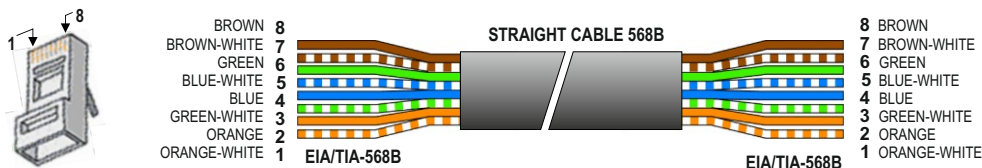

- 13 **INPUT.** This block of terminals allows us connecting an external audio input, be an auxiliary LINE source or an external microphone with the possibility to power it with 12V of phantom power ((activated from the Webserver).

Activation when there is a microphone or background music source can be done with:

- Activation by closing remote input to the ground terminal.
- Activation by detecting audio signal modulation.

**Note:** With an ASYMETRIC connection make a short between MIC (-) and 0V (GND).

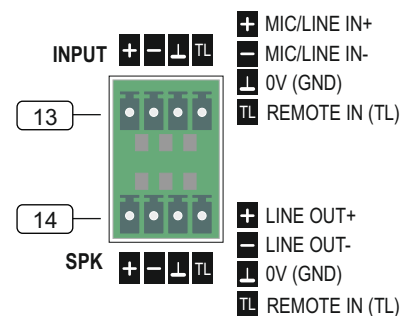

- 14 **SPK.** This euroblock connector is the audio output from the incoming call via IP networks, enabling connection of IPU-1025 in low impedance to a speaker, horn, trumpet or a set of these. While the incoming call is active, the remote control output will remain active (closed contact).

**Caution!** Avoid to connect on the input or line block terminals, direct connections to the ground (including MIC/LINE and TL). In case the line TL it is used a power supply do not refer it to the ground, use isolation.

### 5. DEVICE CONFIGURATION (WEBSERVER).

The IPU-1025 configuration is done by accessing to the IP address assigned to the device by the site administrator if you work in Manual mode assignment (Static Mode), or by the DHCP server if you work in automatic mode.

**Static IP by default is:** 192.168.0.210

**Default user:** admin

**Default password:** admin

#### 5.1 HOME PAGE (Home).

The HOME page of the IPU-100 WEB application allows everyone access to configuration menus and display the status variables of the encoder / decoder.

The screenshot displays the 'SIP EXTENSION Configuration' web interface. On the left is a sidebar menu (1) with options: Home, SIP, Extension, Device, Network, Time, Date, Password, Reset to Factory, and Reboot. The main area is titled 'HOME Menu' and contains a 'Configuration Summary' table (2) and a 'Status Monitor' section (3). The configuration summary includes details like Main Version, MAC Address, IP Mode, Host Name, IP Address, Gateway, DNS Servers, SIP Server IP, SIP Remote, UDP Local Port, Device Extension, Auth, Default Call, UDE PA System, SIP Receiver/Streaming/Paging Desk Priority Levels, SIP Paging Desk Name, IPU-100P Mode, VoIP Codec, Audio III Type, BEEPER Mode, PreVOX/PostVOX Time, TM OUT Activation Mode, Output Volume, and ALIVE Mode. The status monitor shows LED indicators for POWER ON, SERVER DOWN, REGISTER OK, CALL IN, and CALL OUT, along with activation settings for EXTERNALS, TL IN (MIC/LINE), TL OUT (SPEAKER), VOX ACTIVATED, and PHANTOM ACTIVATED. A 'LEVEL MONITOR' section (4) is also present. The footer contains copyright information for UNION DESARROLLOS ELECTRONICOS.



**NOTE:** UNION DESARROLLOS ELECTRONICOS reserves the right to modify all or part of WEB server design in order to offer a better product to their customers, which is why we may appear different from pictures provided in this document and results that you can get the product you have purchased. If you have any doubts consult the technical department of UDE.

#### 1 Menú.

This area specifies the different web pages with configuration parameters.

#### 2 List of available Menus.

This area displays the menu selection icons that the user can select for your device configuration. When the user selects a different menu to the "HOME" (or Main) will be asked to enter a password. If the password is right and match any of the previously stored will then open the desired menu, if not the access will be denied.

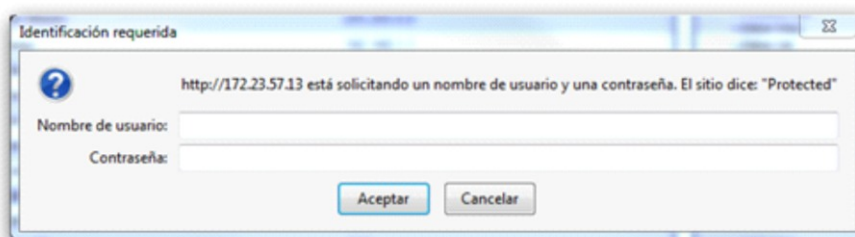

**Attention!** Computer security is a crucial aspect in IP networks. Technical staff is recommended not to store the password default on computers where you can access unqualified personnel to modify the settings of IP equipment.

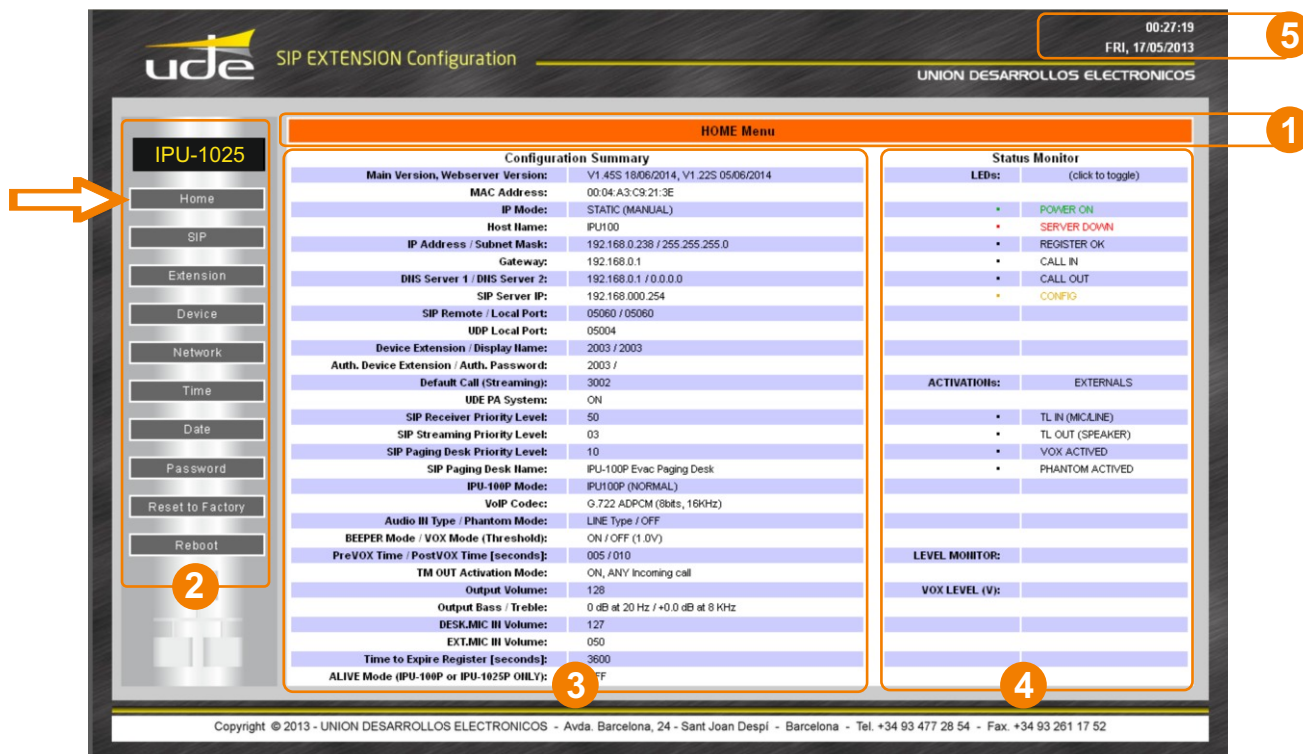

**3 Summary of Configuration Parameters.**

In this area you can check quickly, what are the basic parameters of the device's. Parameters are displayed relative to the Software Application version, the LAN settings (IP, MAC, DNS), the connection parameters to the SIP server (SIP Server IP, data ports, SIP Extension number, SIP authentication password, ...), volume values assigned to the audio inputs and outputs.

**4 Status Monitor.**

In this area you can see three zones:

- **LEDs status.**  
It shows in real time the status (on, off, flashing) of all indicators present on the front panel.
- **Activation signal status.**  
Shows the state of the activation signals of different basic functions such as: VOX activated, MIC activated, etc...
- **Sensor level status.**  
It shows the voltage measurement of the sensors included on the device: 24V Adaptor, 24V Backup Battery, VOX signal level detected, Microphone supply.

**5 Area 5: Time and Date.**

## 5.2 SIP CONFIGURATION (SIP).

The configuration page allows you to configure SIP parameters to ensure the connection to the installation server IPU-360 (SIP server). The parameters configured here must be consistent with SIP server parameters of the system.

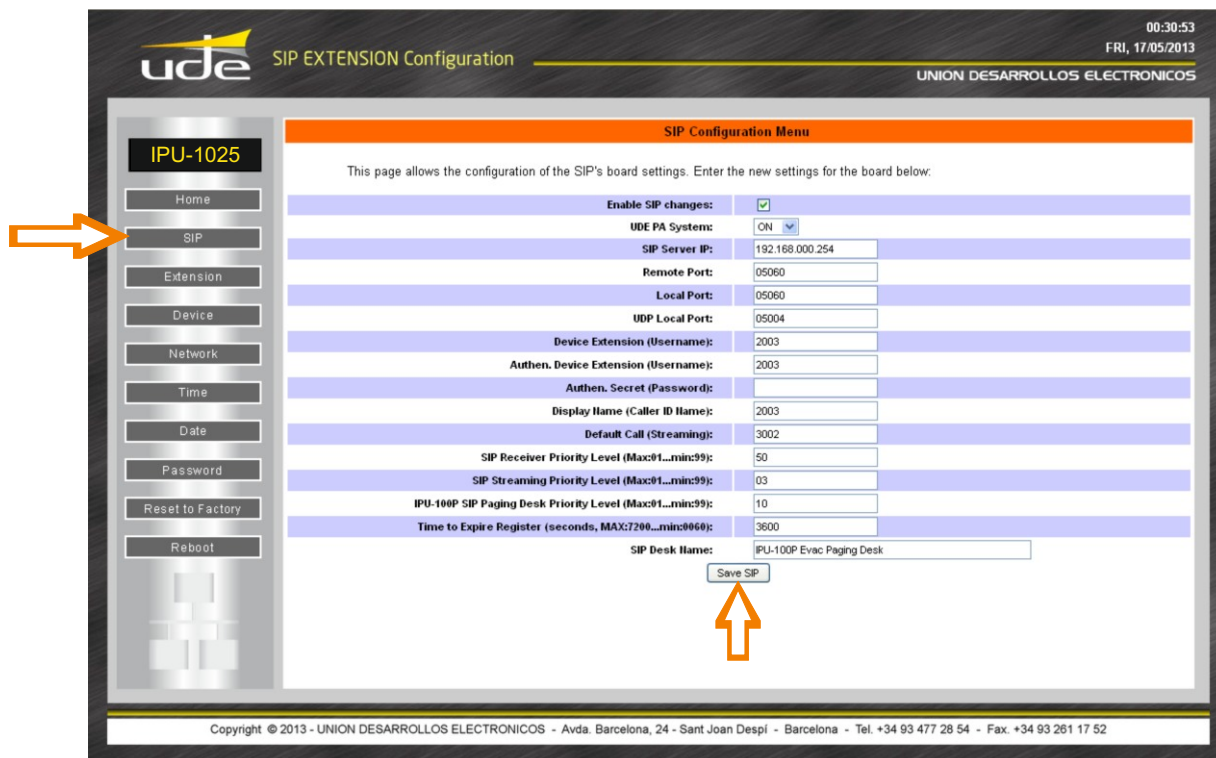

**SIP Configuration Menu**

This page allows the configuration of the SIP's board settings. Enter the new settings for the board below.

Enable SIP changes:	<input checked="" type="checkbox"/>
UDE PA System:	ON
SIP Server IP:	192.168.000.254
Remote Port:	05060
Local Port:	05060
UDP Local Port:	05004
Device Extension (Username):	2003
Authen. Device Extension (Username):	2003
Authen. Secret (Password):	
Display Name (Caller ID Name):	2003
Default Call (Streaming):	3002
SIP Receiver Priority Level (Max:91...min:99):	50
SIP Streaming Priority Level (Max:91...min:99):	03
IPU-100P SIP Paging Desk Priority Level (Max:91...min:99):	10
Time to Expire Register (seconds, MAX:7200...min:9000):	3600
SIP Desk Name:	IPU-100P Evac Paging Desk

Save SIP

Copyright © 2013 - UNION DESARROLLOS ELECTRONICOS - Avda. Barcelona, 24 - Sant Joan Despi - Barcelona - Tel. +34 93 477 28 54 - Fax. +34 93 261 17 52

The configuration parameters are:

### Enable SIP changes

In case the checkbox is checked, the SIP parameters are available to be configured. If not the configuration parameters are blocked.

### UDE PA system

The signaling communication with the server is SIP. Furthermore due to the public address characteristics, the codifiers and decoders requires additional information inside the standardized datagram. Choose ON to use the UDE PA signaling information.

In case of priority or IPU-100P installations, the box must stay in ON option. In case of 100% SIP standard compliance OFF option.

### SIP Server IP Address (format: XXX.XXX.XXX.XXX):

Defines the IP address where the SIP server host. It is required that the address contains the 12 numbers along with the 3 breakpoints.

Example: SIP Server IP: 168.168.0.254



#### ¡Attention!

It is MANDATORY for the correct operation of the IP AUDIO devices of UNION DESARROLLOS ELECTRONICOS that the SIP Server IP address is FIXED address (static type).

**Remote Port (format: XXXXX):**

Define the management TCP port used by the IPU-360 (SIP server) to communicate with our IPU-1025. The standard default value in the device is 05060, you should keep to ensure compatibility with different SIP servers. Remember to always use a configuration with 5 digits.  
Example: Remote Port: **05060**

**Local Port (format: XXXXX):**

Define the management TCP port used by the IPU-1025 to communicate with the IPU-360 (SIP server). The standard default value in the device is 05060, you should keep to ensure compatibility with different SIP servers. Remember to always use a configuration with 5 digits.  
Example: Local Port: **05060**

**UDP Remote Port (format: XXXXX):**

Defines the data transmission UDP port (Voice / INFO) used by the IPU-360 (SIP server) to communicate with the IPU-1025. The standard default value is 00000 (automatic mode), you should keep this value to ensure compatibility with different SIP servers. Remember to always use a configuration with 5 digits.  
Example: UDP Remote Port: **00000**

**UDP Local Port (format: XXXXX):**

Defines the data transmission UDP port (Voice / INFO) used by the IPU-1025 to communicate with the IPU-360 (SIP server) on the installation. The standard default value is 05004 and it is recommended to keep compatibility with different SIP servers. Remember to always use a configuration with 5 digits.  
Example: UDP Local Port: **05004**

**Device extension (username) (from 4 to 8 numbers):**

It is the IPU-1025 SIP identifier for registering to the IPU-360 (SIP server) to be identified as unique equipment in the SIP net, of the public address by IP protocol.

In the systems with UDE Audio equipments, the extensions must be contained in a specific rank:

**Extensions from 1000 to 1999: Decoders**

**Extensions from 2000 to 2999: Audio codifiers**

**Extensions from 3000 to 3999: Music on hold equipments (do not use in other codifiers/decoders configuration)**

**Extensions from 4000 to 4999: IP desk control (with IPU-100P).**

Choose the extension number depending in which application the IPU-1025 should work.

Some extensions ranks have additional features:

**Codifier extension between 2000 and 2499, do not activate the TM OUT in the decoder.**

**Codifier extension between 2500 and 2999, activate the TM OUT in the decoder.**

**All extensions between 4000 and 4999 will activate the decoder TM OUT.**

Example:

Local Extension: **1002 2536 1589 4001**

**Authen. Device Extension (Username): (Max: 8 alphanumeric characters):**

Defines the user id in the system when it is working in a secure transmission mode.

Example: Authen. ID: **12345678**  
**AreaCo\_1**

This parameter is optional, if not required then leave it blank.

**Attention!**

If you have questions about your authenticated user name or password, contact your Network Administrator or technical staff in charge of the IPU-360 configuration (SIP server).

Basic Alphanumeric characters are recommended (standard ASCII codes between 32 and 126), excluding special characters or accents to avoid to block the access in case of any network device or the server does not understand these characters.

---

**Authen. Secret (Password):** (Max: 8 alphanumeric characters):

Defines the user password when it is working in a secure transmission mode.

Example: Authen. PASSW.: **zX\_0!%¿#** (No utilizar caracteres especiales)

This parameter is required if the parameter "Authenticated ID" is active, otherwise please leave it blank.

---

**Display Name (Caller ID Name):** (format: XXXX):

---

**Default Call (Streaming):** (format: XXXX):

Define the extension to call for activating the background music or for the voice message broadcast from a microphone.

Valid values for any extension must be between 3000 and 3999.

Example:

Default Call (streaming): **3400**

---

**SIP Receiver Priority Level (Max:01...min:99):** (Not use)

---

**SIP Streaming Priority Level (Max:01...min:99):**

If the UDE PA system is active and the IPU-1025 in codifier mode, a priority can be applied and the IPU-360 will manage. This priority should be between 01 (max priority) in consequence will cut other emitters and 99 (lowest priority).

These characteristics give tools to program de PA system over IP. If you need more information of the max number of priorities, consult the IPU-360 datasheet.

The **SIP Streaming Priority Level** must be configured with audio sources like MP3 players or Microphones like PZ-40 for Music on hold calls. It is a different priority from the **IPU-100P SIP Paging Desk Priority**, that only concerns desk control microphones.

---

**IPU-100P SIP Paging Desk Priority Level (Max:01...min:99):**

These characteristics give tools to program de PA system over IP, if the IPU-1025 is linked with an IPU-100P (desk control), a priority desk can be applied. This priority must be between 01 (max priority) in consequence will cut other desk control and 99 (lowest priority).

These characteristics give tools to program de PA system over IP. If you need more information of the max number of priorities, consult the IPU-360 datasheet.

The **IPU-100P SIP Paging Desk Priority Level** is setting for IPU-100 linked with IPU-100P, is different from the **SIP Streaming Priority** for audio sources or microphones.

---

**Time to Expire Register (seconds, MAX:7200...min:0060):**

Register time for SIP server update, recommended time: 3600 seconds.

---

**SIP Desk Name (Max: 32 alphanumeric characters):**

The IPU-100P desk control, has a label identification name in the main screen to identified from other desk control in the installation.

SIP Desk Name: **Hall Hotel Las Vegas** (20 characters including spaces)

---



**NOTE:** If the IPU-1025 is not linked with an IPU-100P (desk control), this configuration parameter is disabled.

---

5.3 EXTENSION SIP CONFIGURATION (ONLY IPU-100P mode).

The public address zone configuration with an IPU-100P desk control must be done with a IPU-1025 codifier. It is not possible to make the desk control configuration with the touch screen. The extension web server of the IPU-1025 menu will allow erasing all IPU-100P zone buttons or editing the PA buttons of the IPU-100P desk control.

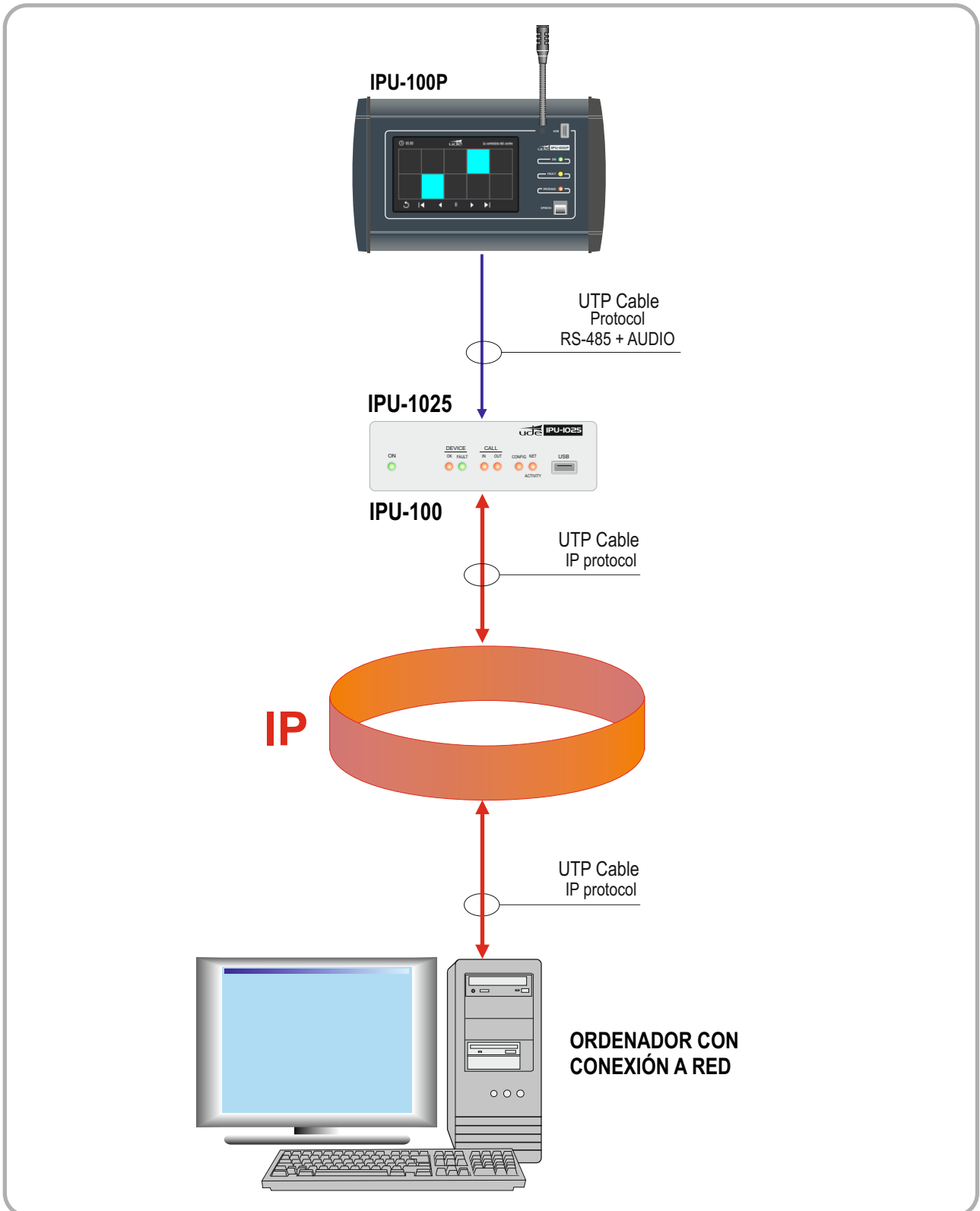

The screen structure of the IPU-100P is:

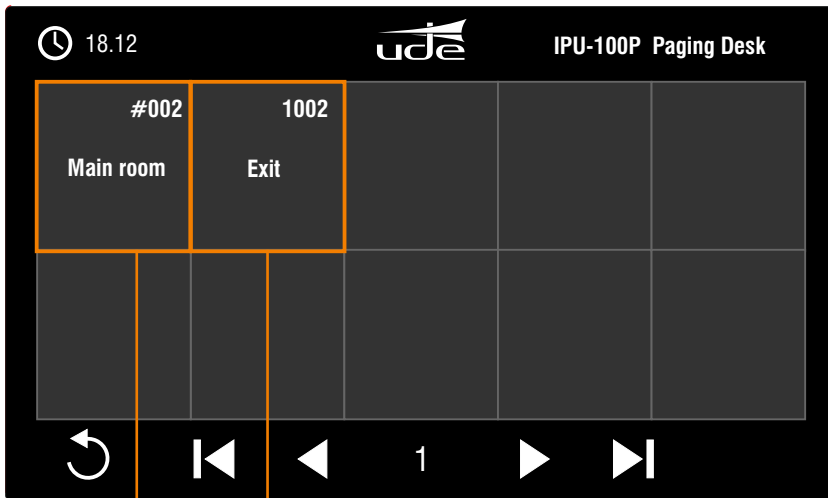

The main page have 10 PA buttons and navigation icons.

Each button/ zone can be edited with a description text and numbers of zones to call (decoders). The maximum number of PA zones will be a totally broadcast message for all the zones configured in the IPU-360 (SIP server).

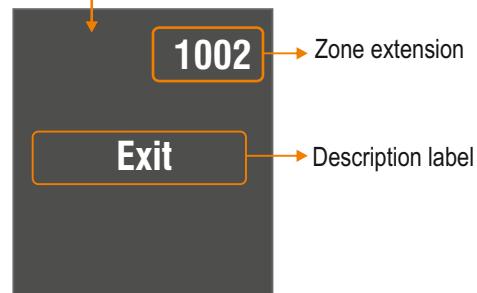
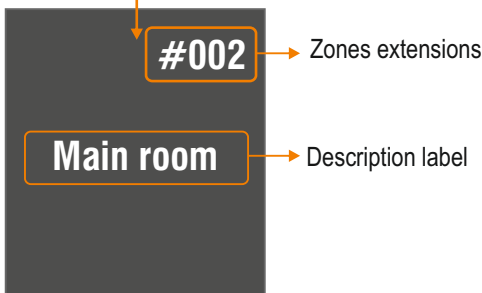

- To edit the IPU-100P zones, exists 2 ways:
1. Erasing the whole desk control memory.
  2. Editing zones keeping the zones configuration.

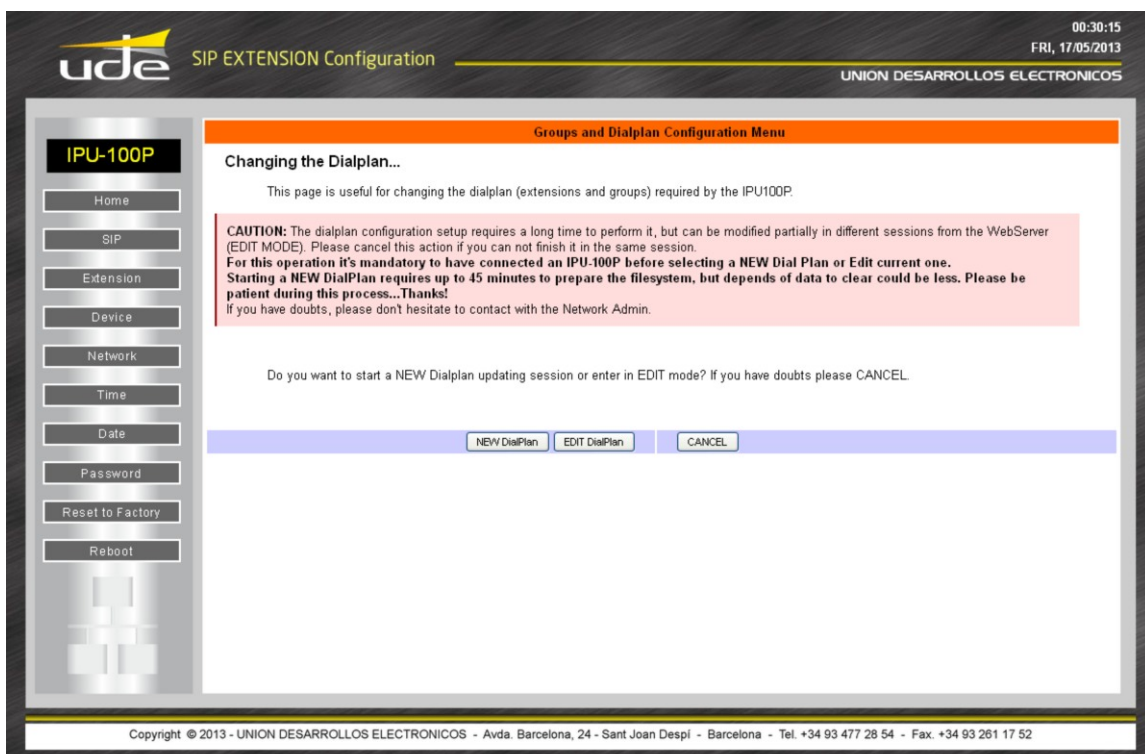

5.3.1 ERASING & EDITING (Extensions)

Extension main page

In the “Extension” page click on: **NEW DialPLAN**

With this selection the IPU-100P begin the process to erase all the information in memory. The data structure will be the factory profile.



**Caution!**

The erasing process is irreversible; in case of error the memory information cannot be recovered.

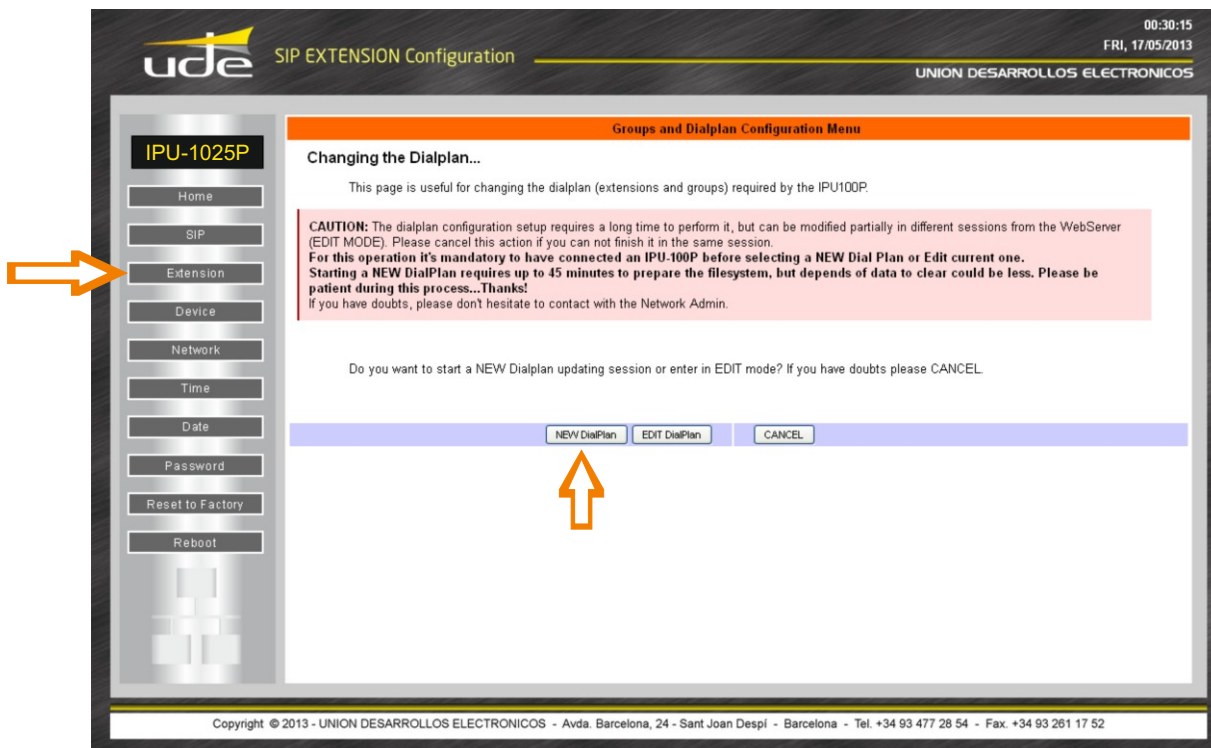

Erasing process page

Depending on the amount of information saved on memory, the erasing process can spend from 10 seconds to 44 minutes to erase all data.

The IPU-100P screen while the erase process is execute will keep out of work for any paging call. Also a deleting data message will be printed to give user information.

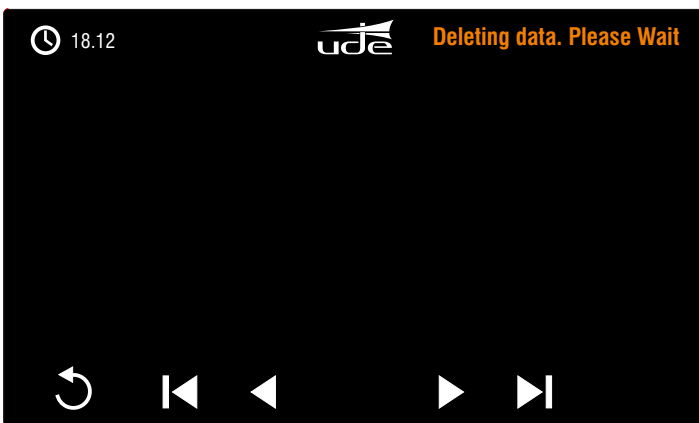
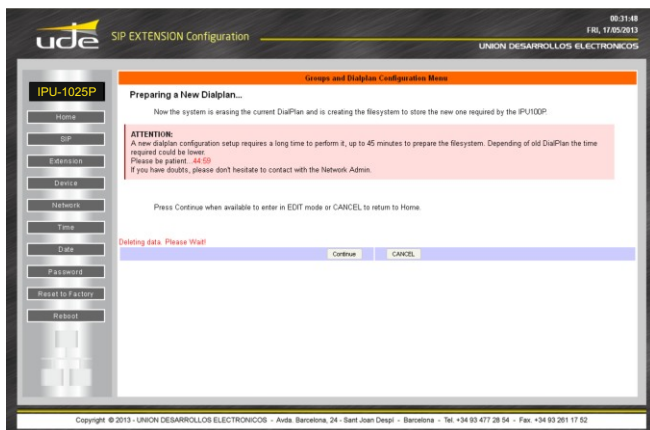

Zone edit page

When the erase process has finished, the webpage will be redirected to the zone edit webpage, also the touch screen of the IPU-100P will work.

5.3.2 P.A. ZONES EDIT PAGE (Extensions).

Each IPU-100 can be linked only with one IPU-100P. The connection between the codifier and the desk control must be done point-to-point, and other configuration must be rejected.

To access the edit zone page, click on “**Extension**” icon in the left menu and click : **EDIT DialPlan**  
 If you did the erase memory process, you will be redirected to the PA zones edit page of the IPU-100P.

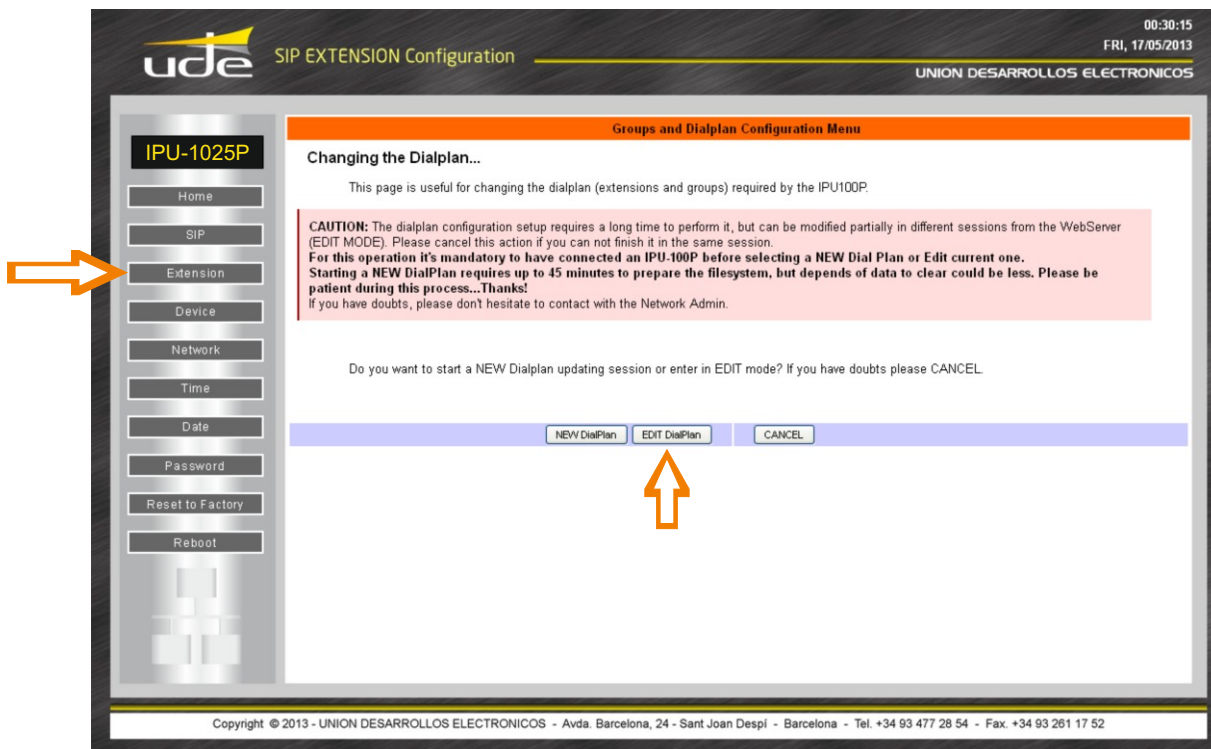

The zone edit page has two main areas, one is the general navigation and edition of the buttons that already exist in the desk control (IPU-100P) and another area allows editing one specific button, adding the label and the different extensions that will call.

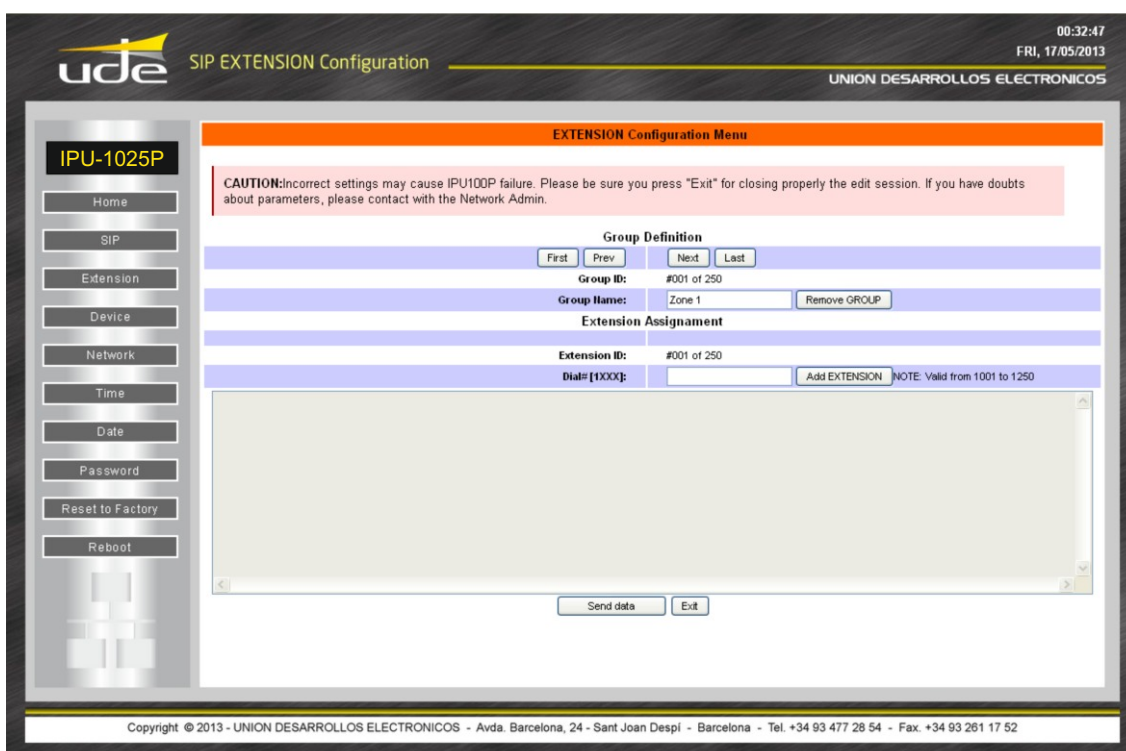

EDIT ZONE PAGE

**1 IPU-100P buttons navigator.** Exist 4 different icons to navigate along all the buttons of the touchscreen.

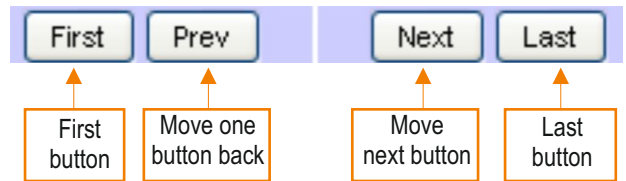

**2 Button edition indicator**

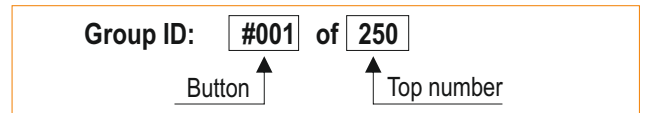

**3 Group name** Each IPU-100P button can show a label to give more information about the zone to call in that button, the label can have a maximum of 20 alphanumeric letters.

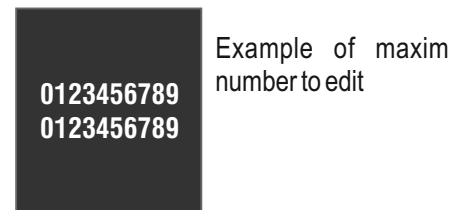

**4 Extension configuration in a button.**

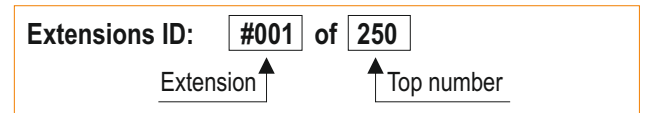

**5 Extension configuration**

To enter the extensions in a button, the configuration must be done one by one extension, that is enter one extension send the information and successively for all the extension to be in one button. Furthermore the decoders extension are in the Rank between 1000 and 1999. To make it more simple is precise to type the last 3 digits of the extension, the first digit (number 1) is automatically processed.

**6 Extension cache:**

The extension are saved in a cache memory waiting to be sent to the IPU-100P (the Rank of the extensions is between 1000 and 1999). For example when extension 1300 (typing 300), and clicking "Add EXTENSION" the new number appears in the extension

**7 Validate**

When all extensions, labels and buttons are ready, click on "Send data". This action must be done every time one button is edited.

**Button configuration example**

This example contains the configuration of 3 IPU-100P buttons, with this characteristics:

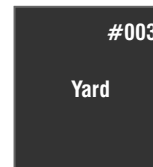
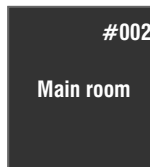
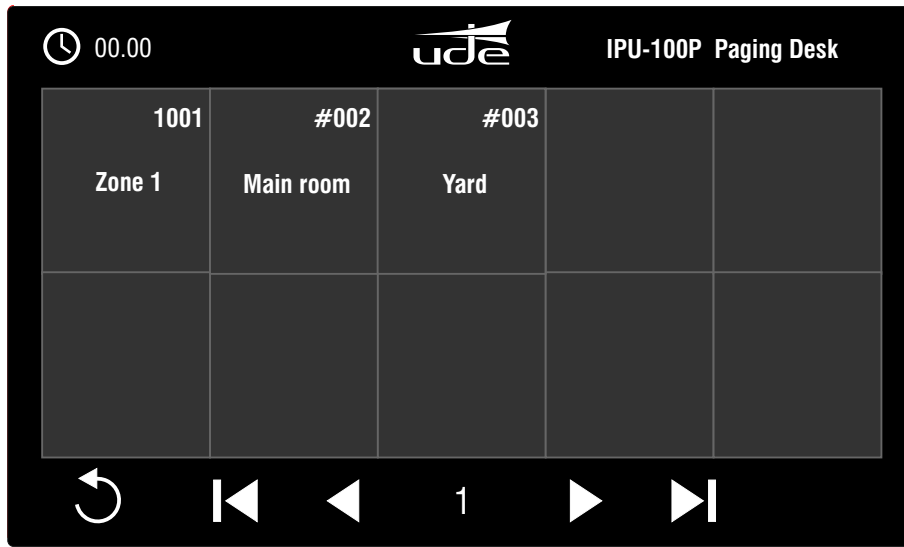

**BOTTON 1**

Button name: **Zone 1**  
Extension to call: **1001**

**BOTTON 2**

Button name: **Main room**  
Extension to call: **1002, 1400**

**BOTTON 3**

Button name: **Yard**  
Extension to call: **1003, 1004, 1010**

**Button 1 edition**

Number of extension to call by the button.  
**Type new label.**  
Click on **“Send data”**.

**Button 2 edition**

Number of extension to call by the button.  
**Type new label.**  
Click on **“Send data”**.

**Button 3 edition**

Number of extension to call by the button.  
**Type new label.**  
Click on **“Send data”**.

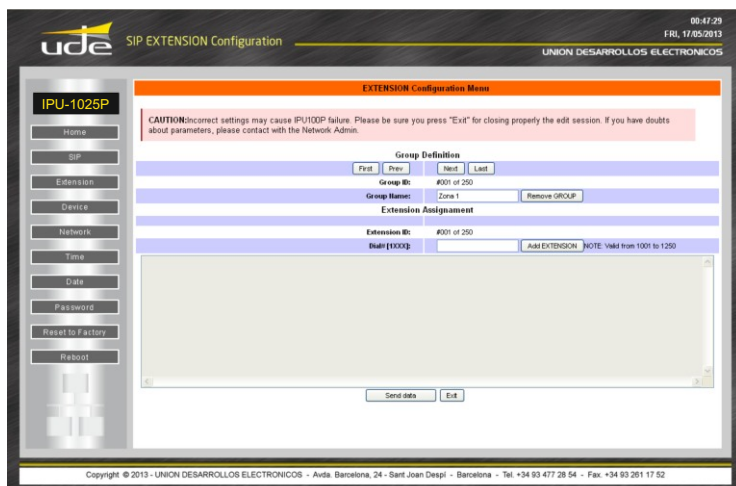

**ZONE EDIT PAGE**

Without any data inside the system, the webpage should look like:

- Edition of button 1.
- First extension to configure inside the button 1.

**EXTENSION Configuration Menu**

**CAUTION:** Incorrect settings may cause IPU100P failure. Please be sure you press "Exit" for closing properly the edit session. If you have doubts about parameters, please contact with the Network Admin.

**Group Definition**

First Prev Next Last

Group ID: #001 of 250

1 Group Name: Zona 1 Remove GROUP

**Extension Assignment**

Extension ID: #001 of 250

2 Dial# [1XXX]: 001 Add EXTENSION 3 Valid from 1001 to 1250

1001

4

5 Send data Exit

**BUTTON 1 EDITION**

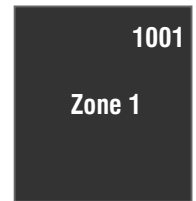

**BUTTON 1 EDITION**

The parameters to configure for button 1:

1. Button 1 label.
2. Extension to call: 001 (equal to 1001).
3. Confirm extension with: **Add EXTENSION**
4. Extension 1001 appears in the extension box.
5. In button number one has only one extension to call (1001), there is no other extension to configure and configuration must be uploaded. Click on button: **Send data**.

Button 1 configuration has been saved and screen shows the new button.

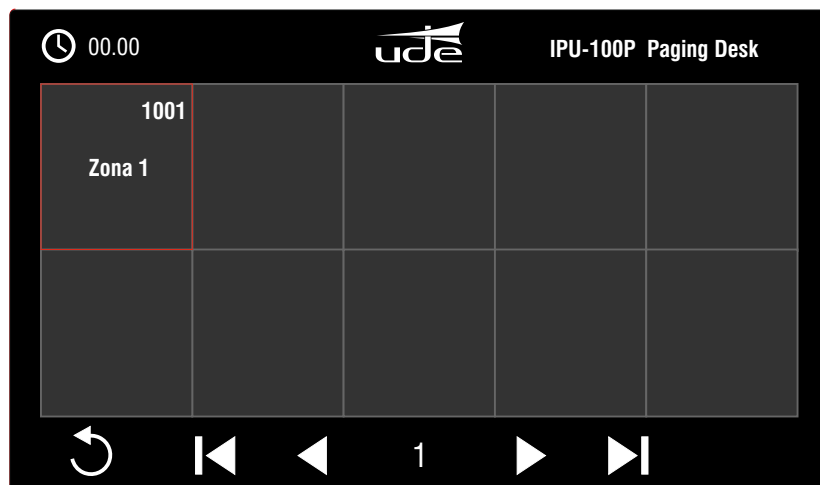

**EXTENSION Configuration Menu**

**CAUTION:** Incorrect settings may cause IPU100P failure. Please be sure you press "Exit" for closing properly the edit session. If you have doubts about parameters, please contact with the Network Admin.

**Group Definition**

First Prev Next Last

Group ID: #001 of 250

1 Group Name: Comedor Remove GROUP

**Extension Assignment**

Extension ID: #001 of 250

2 2B Dial# [1XXX]: 002 Add EXTENSION 3 3B on 1001 to 1250

1002, 1400  
4 4B

5 Send data Exit

**BUTTON 2 EDITION**



**BUTTON 2 EDITION**

**The parameters to configure for button 2:**

1. Button 2 label.
2. Extension to call: 002 (equal to 1002).
3. Confirm extension with: **Add EXTENSION**
4. Extension 1002 appears in the extension box.
- 2B. Type the second extension to call in button 2, this is extension 400 (equal to 1400).
- 3B. Confirm extension with: **Add EXTENSION**
- 4B. Extension 1400 appears in the extension box.
5. In button number two has only two extensions to call (1002, 1400), there is no other extension to configure and configuration must be uploaded. Click on button: **Send data**.

Button 2 configuration has been saved and screen shows the new button.

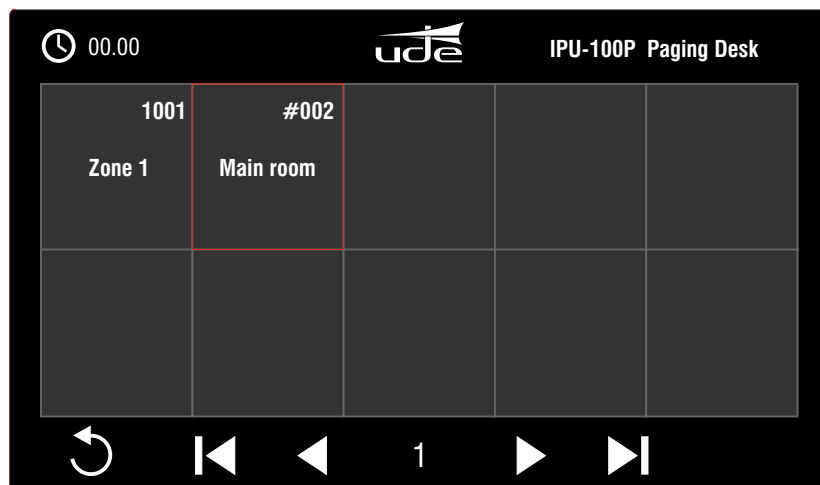

**EXTENSION Configuration Menu**

**CAUTION:** Incorrect settings may cause IPU100P failure. Please be sure you press "Exit" for closing properly the edit session. If you have doubts about parameters, please contact with the Network Admin.

**Group Definition**

First Prev Next Last

Group ID: #001 of 250

1 Group Name: Zona alta Remove GROUP

**Extension Assignment**

Extension ID: #001 of 250

2 2B 2C Dial# [1XXX]: 003 Add EXTENSION NO 3 3B 3C 001 to 1250

1003, 1004, 1010  
4 4B 4C

5 Send data Exit

**BUTTON 3 EDITION**

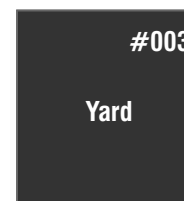

**BUTTON 3 EDITION**

**The parameters to configure for button 3:**

1. Button 3 label.
2. Extension to call: 003 (equal to 1003).
3. Confirm extension with: **Add EXTENSION**
4. Extension 1003 appears in the extension box.
- 2B. Type the second extension to call in button 3, this is extension 004 (equal to 1004).
- 3B. Confirm extension with: **Add EXTENSION**
- 4B. Extension 1004 appears in the extension box.
- 2C. Type the second extension to call in button 3, this is extension 010 (equal to 1010).
- 3C. Confirm extension with: **Add EXTENSION**
- 4C. Extension 1010 appears in the extension box.
5. In button number three has three extensions to call (1003, 1004 and 1010), there is no other extension to configure and configuration must be uploaded. Click on button: **Send data**.

Button 3 configuration has been saved and screen shows the new button.

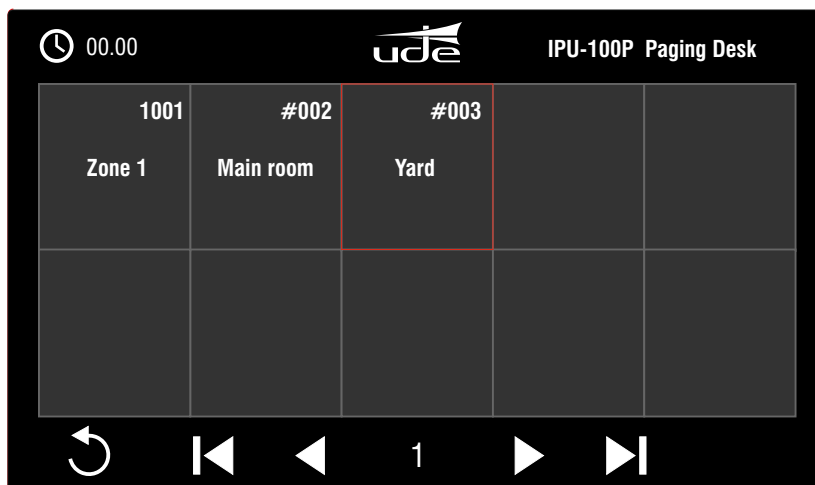

**5.4. DEVICE CONFIGURATION. (Device).**

This section allows you to configure the analog parameters and modes of the device.

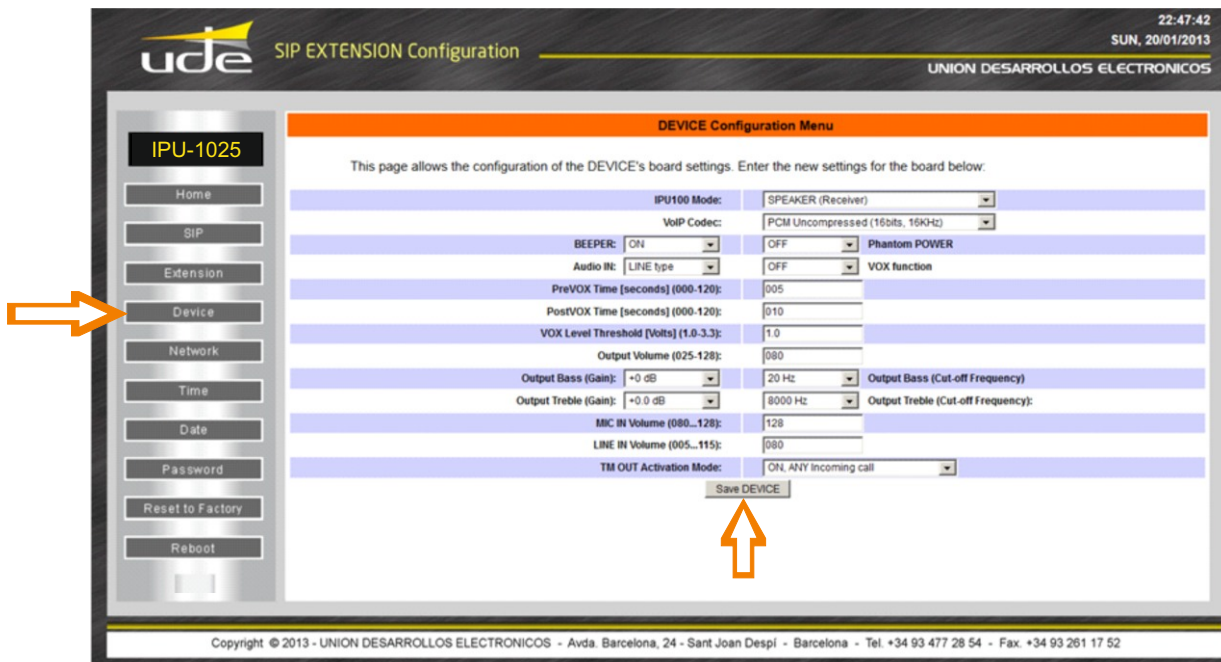

**IPU-100 Mode.**

To set the mode of the IPU-1025 between 4 options:

**SPEAKER (Receiver).**

The IPU-1025 behaves as audio reception point and is ready to receive calls ONLY. This option is set by Factory default.

**AMPLIFIER (Receiver).**

The IPU-1025 behaves as audio reception point, allowing you to receive IP calls, with the difference that when it receive no IP calls, then IPU-1025 will amplify the audio signal present at the INPUT connector (MIC/LINE).

**TREAMING (Emitter).**

The IPU-1025 will act as an audio emitter point and it will be ready to make calls ONLY (VOICE/MUSIC). The streaming is always done to the extension configured as "Default Call" in the SIP configuration section..

**IPU-100P (Normal).**

The IPU-1025 will act as an audio emitter point (VOICE mode) being synchronized with the IP Paging Desk connected to the AUDIO LINK. For more details refer to the User Manual of the IPU-100P IP Paging Desk.



**Attention!** Do not use the IPU-100P Mode when no IP Paging Desk is connected to the AUDIO LINK terminal as it can lock the IPU-1025 temporarily until you perform a reboot of the device.

**VoIP Codec.**

Allows selection of the codec to be used to encode both outgoing and incoming calls when the audio source is a microphone. The options are as follows:

- **G.711 (u-Law).** 8 bits logarithmic compression and 8KHz sampling frequency. Quality: Low (As Factory Default).
- **G.711 (a-Law).** 8 bits logarithmic compression and 8KHz sampling frequency. Quality: Low.
- **G.722(ADPCM).** 8 bits Adaptive Linear Compression and 16KHz sampling frequency. Quality: Medium.
- **PCM Uncompressed (8kHz).** 16 bits without compression and 8KHz sampling frequency. Quality: Good.
- **PCM Uncompressed (16kHz).** 16 bits without compression and 16KHz sampling frequency. Quality: Very Good.

**BEEPER function:**

Activate the acoustic buzzer.  
OFF (as Factory Default).  
ON

**Phantom POWER:**

Enable the 12V phantom power on MIC input line.  
OFF (as Factory Default).  
+12VDC.

**Audio IN.**

Select which audio source will be used in "streaming" mode of the two possible ones:  
MIC Type (as Factory Default).  
LINE Type.

**(\*\*) VOX function:**

Allows the function of "streaming" is activated by the VOX controlled method, activate the equipment to detect an audio signal.  
OFF (as Factory Default).  
ON

**(\*\*) PreVOX time (format: XXX):**

Select between 000 and 120 seconds, the time it will spend in the detected signal condition before being made the audio "streaming" activation call. Always use a 3-digit format.  
Example:       **000**   **010**   **120**

**(\*\*) PostVOX time (format: XXX):**

Select between 000 and 120 seconds, the time it will spend in the no-signal condition before being canceled the audio "streaming" call.  
Always use a 3-digit format.  
Example:       **000**   **010**   **120**

**(\*\*) VOX Level (format: X.X):**

Selects the minimum threshold for detecting the audio signal as active.  
Always use a 3-digit format (minimum 1.0V, maximum 3.3V).  
Example:       **1.1**   **2.7**   **3.3**

**Output Volume (format: XXX):**

Select between 025 and 128, the volume applied to the output which you connect the amplifier.  
Always use a 3-digit format.  
Example:       **025** (mín.)       **080**   **128** (max.)

**(\*\*) Output Bass (Gain):**

Filter can be used to supplement the low frequency response, from +0dB (default set) to +15dB.  
Example:       **+0dB** (mín.)   **+15dB** (max.)

**(\*\*) Output Bass (Cut-off Frequency):**

Filter cut-off frequency for supplement low frequency response.  
Example:       **20Hz** (mín.)   **150Hz** (max.)

**(\*\*) Options ONLY VALID when SPEAKER (Receiver) mode is active.**

**(\*\*) Output Treble (Gain):**

Filter can be used to attenuate/supplement the high frequency response, from -12dB to +10.5dB.

Example:           **-12dB** (max. attenuation)   **+0dB** (default)   **+10.5dB** (max. gain)

**(\*\*) Output Treble (Cut-off Frequency):**

Filter cut-off frequency for attenuate/supplement high frequency response.

Example:           **1kHz** (mín.)           **8kHz** (max)

**MIC IN Volume (format: XXX):**

Select between 088 and 128, the gain level to be applied to microphone connected to IPU-1025.

Always use a 3-digit format.

Example:           **080** (mín.)           **090**           **128** (max.)

**LINE IN Volume (format: XXX):**

Select between 005 and 128, the gain level to be applied to the signal line connected to the IPU-1025.

Always use a 3-digit format.

Example:           **005** (mín.)           **050**           **128** (max.)

**DESK.MIC IN Volume (format: XXX):**

Select between 070 and 127, the gain level to be applied to audio from the desk control IPU-100P connected to the IPU-1025.

This configuration parameter can only be used in IPU-100P mode.

Always use a 3-digit format.

Example:           **070** (mín.)           **090**           **127** (max.)

**EXT.MIC IN Volume (format: XXX):**

Select between 010 and 128, the gain level to be applied to audio from the external microphone of the desk control (IPU-100P) connected to the IPU-1025 (CM-23 is the recommended microphone). This configuration parameter can only be used in IPU-100P mode.

Always use a 3-digit format.

Example:           **010** (mín.)           **090**           **128** (max.)

**TM OUT Activation Mode:**

There are few input calls (depending on the extension) that allow the activation of this mode:

**OFF:**

**ON, voice calls:** Any incoming call with the server specifications will activate the TM OUT.

**ON, all calls:** Only incoming calls from desk control (IPU-100P), will activate the TM OUT.

**(\*\*) Options ONLY VALID when SPEAKER (Recever) mode is active.****SERVER SPECIFICATIONS**

Codifier extension in the range **(2500 - 2999)** and **(4000 - 4999)** activate the TM OUT in the decoder.

### 5.5 CONFIGURATION LAN. (Network).

This section describes how to set NETWORK configuration parameters basic to any local area network (LAN). Follow the steps below.

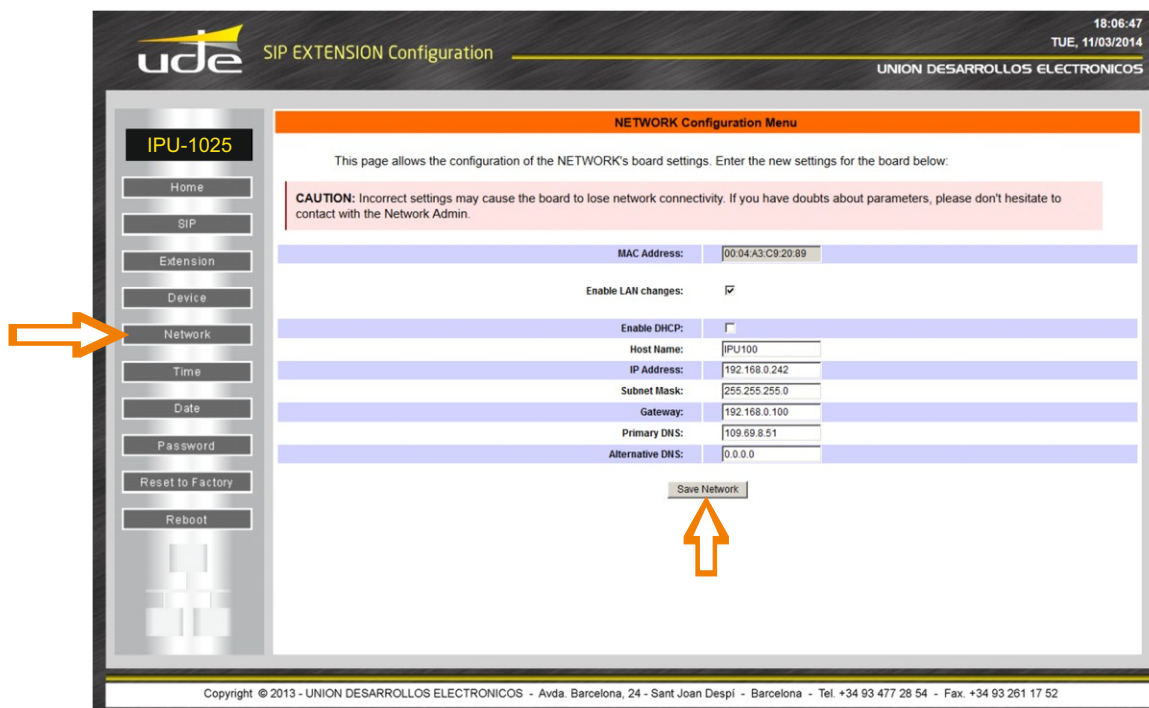

The configuration parameters are:

#### Enable LAN changes.

When this option is unchecked, the status of the current connection is shown. Check the "Enable LAN changes" to modify any of them. Note that after setting this option, the other options are enabled.

#### Enable DHCP.

Ask the network administrator to ensure the working mode enabled on your IP network to determine whether IP address allocation is automatic (AUTO) or static (fixed). If the required operating mode is AUTO, then you must enable this mode on the box marked "Enable DHCP".

**Attention!** It is highly recommended for the correct operation of the IP AUDIO equipment of UNION DESARROLLOS ELECTRONICOS that the IP address of each IPU-1025 devices on the network is set to STATIC mode and be a fixed address.

#### Host Name (Max: 15 Characters (1)):

Defines the name of our IPU-1025 within the group of interconnected devices to differentiate it from the rest in a character format. Follow NETBIOS format that enable us to access your device from a web browser without knowing its physical IP address, user being easier to remember since you can assign a name representative of the function or area where it is being serviced.

Example: Host Name (NETBIOS): **IPU100** (Host Name por defecto de fábrica)  
**IPU100\_HALL OFFICE.1STFLOOR CHECKOUT\_LANE.3**

(1) NETBIOS Restriction: 15 alphanumeric characters with basic punctuation characters (period, hyphen, underscore) and NO spaces.

**IP Address (format: XXX.XXX.XXX.XXX):**

Parameter to set the IP address of the device. It is required that the address contains the 12 numbers along with the 3 breakpoints. A valid example of configuration would be:

Example: IP device: **192.168.000.210** (IP Address by Factory default)



**Attention!**

If the IP assignment mode is Static or FIXED selected, this IP address should be provided by the Network Administrator. Please contact with him before changing this setting as it can affect the proper functioning of the IP network.

**SubNet Mask (format: XXX.XXX.XXX.XXX):**

Defines the subnet mask assigned to your fixed IP. These data should be provided by the Network Administrator.

Example: SubNet Mask: **255.255.255.000** (Subnet Mask by Factory default)

**GateWay (format: XXX.XXX.XXX.XXX):**

Defines the address of the device on the local area network that allows you to connect to other computers and usually assigned IP address when the system is configured in DHCP mode (or automatic).

Example: GateWay: **192.168.000.001** (Gateway IP by Factory default)

**Primary DNS (format: XXX.XXX.XXX.XXX):**

Defines the address of the device on the local area network or external that will allow you to connect to other computers in the world through URLs.

This address can be not necessary for normal use of your device, then assign it a null address "000.000.000.000" or simply leaves it blank.

Example of valid Alternative DNS: Primary DNS IP: **192.168.000.001** (Primary DNS IP by Factory default)

**Alternative DNS o Secondary (format: XXX.XXX.XXX.XXX):**

Defines the address of the device on the local area network or external that will allow you to connect to other computers in the world through URLs, in case the Primary DNS does not work temporarily. This address can be not necessary for the normal use of your device, then assign a null address "000.000.000.000" or simply leaves it blank.

Example of valid Alternative DNS: Alternative DNS IP: **000.000.000.000** (Secondary DNS IP by Factory default).

**Save NETWORK:**

For the changes to be validated must be pressed the button "**Save Network**". As these changes modify the essential connection parameters, IPU-1025 must be reset and that is why the "**Reboot In Progress**" screen is displayed temporary.

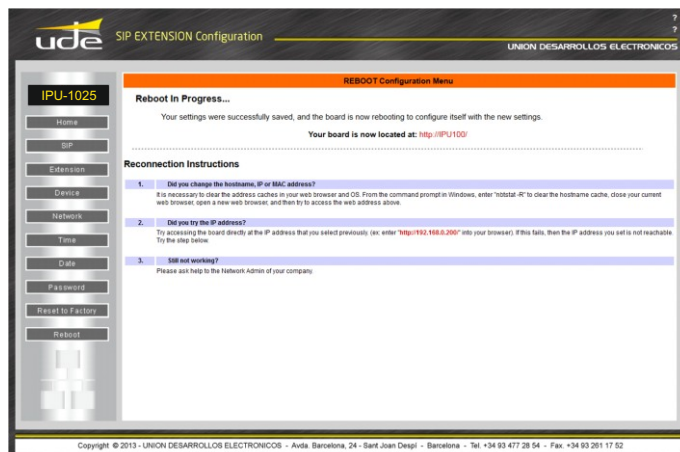

**5.6 TIME CONFIGURATION. (Time).**

Select hour, minute and second on the 24h format, and always using 2 digits. Click on **"Save TIME"** to update the system clock.

**TIME Configuration Menu**

This page allows the configuration of the TIME's board settings. Enter the new settings for the board below:

Hour (hh):	<input type="text" value="22"/>
Minute (mm):	<input type="text" value="45"/>
Seconds (ss):	<input type="text" value="55"/>

Always use the format: (hh/mm/ss)  
 Example:  
 Hour (hh): 22  
 Minute (mm): 45  
 Seconds (ss): 55

Copyright © 2013 - UNION DESARROLLOS ELECTRONICOS - Avda. Barcelona, 24 - Sant Joan Despi - Barcelona - Tel. +34 93 477 28 54 - Fax. +34 93 261 17 52

**5.7. DATE CONFIGURATION (Date).**

Enter the day, month and year desired, considering always use 2 digits format. Click on **"Save DATE"** to update the system calendar.

**DATE Configuration Menu**

This page allows the configuration of the DATE's board settings. Enter the new settings for the board below:

Day (dd):	<input type="text" value="20"/>
Month (mm):	<input type="text" value="01"/>
Year (yy):	<input type="text" value="13"/>

Always use the format: (dd/mm/yy)  
 Example:  
 Day (dd): 20  
 Month (mm): 01  
 Year (yy): 13

Copyright © 2013 - UNION DESARROLLOS ELECTRONICOS - Avda. Barcelona, 24 - Sant Joan Despi - Barcelona - Tel. +34 93 477 28 54 - Fax. +34 93 261 17 52

### 5.8 PASSWORD CONFIGURATION DEVICE (Password).

The factory login and passwords are:

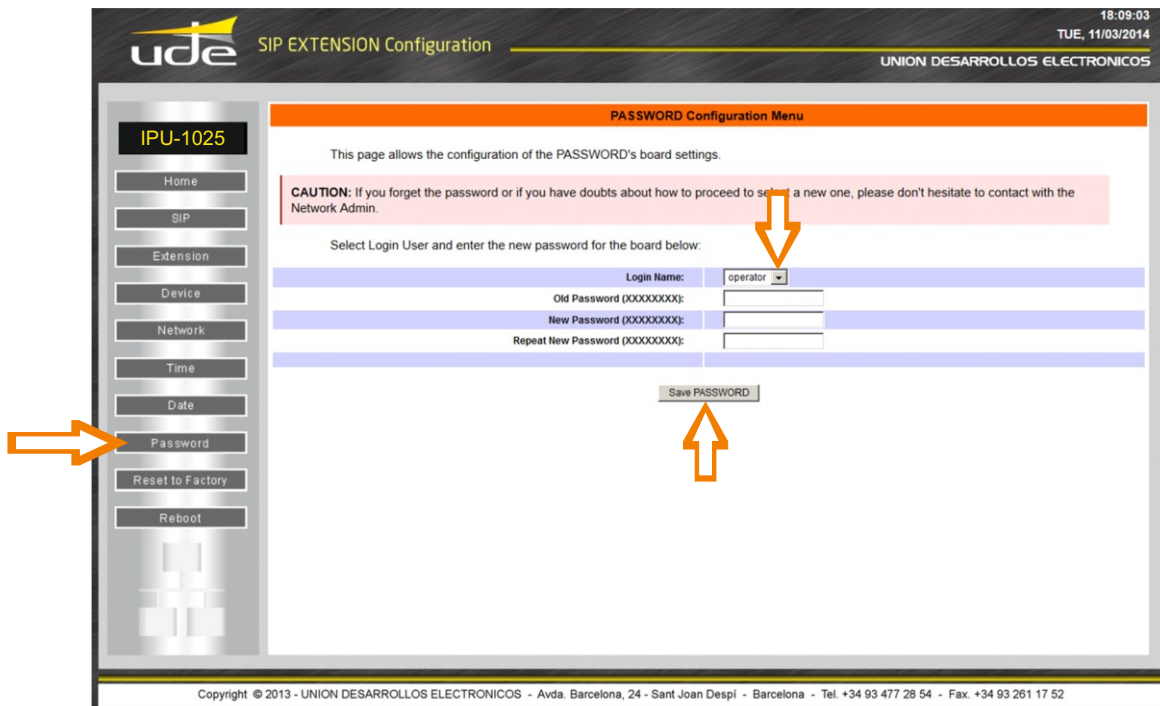

18:09:03  
TUE, 11/03/2014  
UNION DESARROLLOS ELECTRONICOS

**IPU-1025**

Home  
SIP  
Extension  
Device  
Network  
Time  
Date  
Password  
Reset to Factory  
Reboot

**PASSWORD Configuration Menu**

This page allows the configuration of the PASSWORD's board settings.

**CAUTION:** If you forget the password or if you have doubts about how to proceed to set a new one, please don't hesitate to contact with the Network Admin.

Select Login User and enter the new password for the board below:

Login Name: operator

Old Password (XXXXXXXX):

New Password (XXXXXXXX):

Repeat New Password (XXXXXXXX):

Save PASSWORD

Copyright © 2013 - UNION DESARROLLOS ELECTRONICOS - Avda. Barcelona, 24 - Sant Joan Despí - Barcelona - Tel. +34 93 477 28 54 - Fax. +34 93 261 17 52

To change the password first select the desired password type,

- operator
- admin
- supervis

then enter the information requested:

**OLD password:**

8 alphanumeric characters with ASCII between 32 and 127.

**NEW password:**

8 alphanumeric characters with ASCII between 32 and 127.

**Type again NEW password:**

8 alphanumeric characters with ASCII between 32 and 127.

Confirm password: "**Save PASSWORD**"



**Attention!**

The new password will take effect only if the old password has been entered correctly and has not been wrong to confirm the new password. The system will reset to the new password take effect.

### 5.9 RESET TO FACTORY (Reset to Factory)

The IPU-1025 can be configured with the factory configuration.

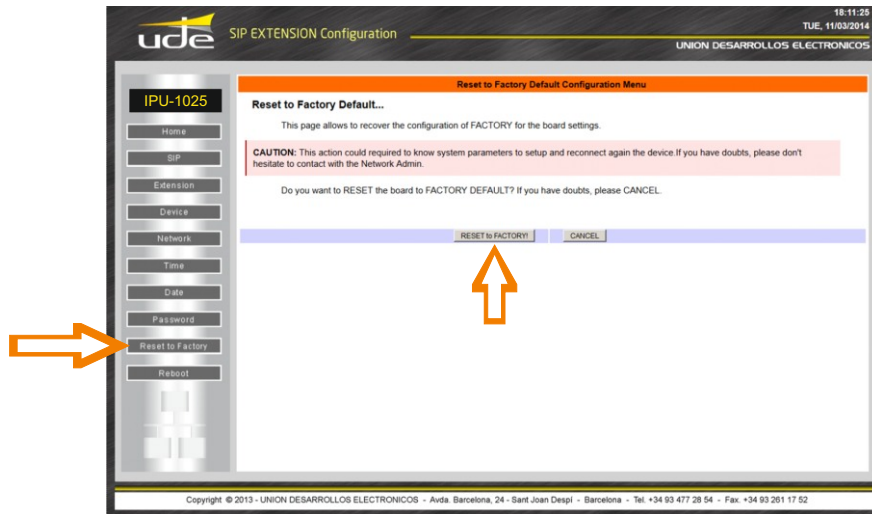

**Caution!** The erasing process is irreversible; in case of error the memory information cannot be recovered.

### 5.10 REMOTE REBOOT (Reboot)

The IPU-1025 can be remote rebooted just click to the **Reboot** icon on the left menu and confirm clicking on **REBOOT!** icon.

